

M14

Imam
Ali Zaynul
Aabideen
(pbuh)

Imam
Muhammad
Al-Baqir
(pbuh)

Imam
Ja'fer
As-Sadiq
(pbuh)

Imam
Musa
Al-Kadhim
(pbuh)

Imam
Husayn
(pbuh)

Imam
Ali Ar-
Ridha
(pbuh)

Let me learn about Aimmatiy

Imam
Hasan
(pbuh)

Imam
Muhammad
At-Taqi
(pbuh)

Imam Ali
(pbuh)

Imam
Muhammad
Al-Mahdi
(pbuh)

Imam
Hasan
Al-Askery
(pbuh)

Imam
Ali An-Naqi
(pbuh)

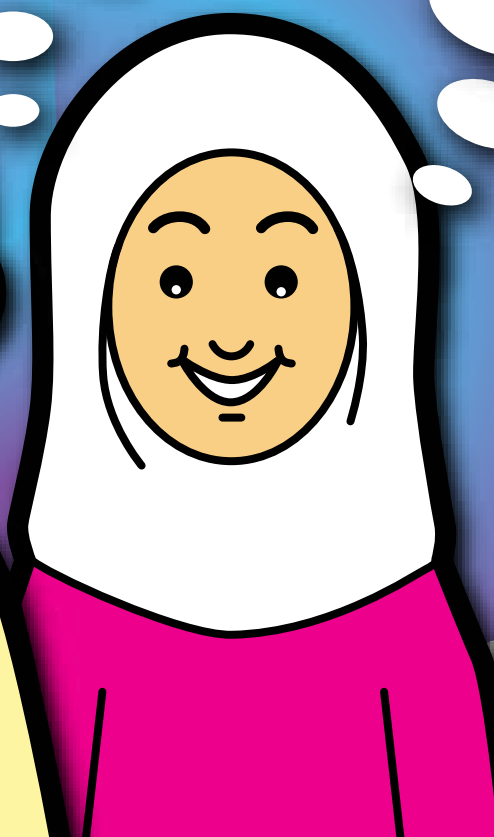
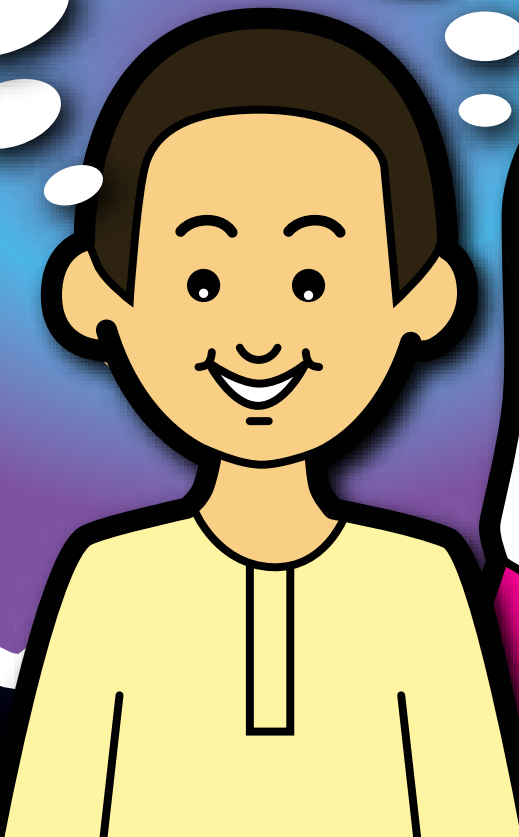

CONTENTS PAGE

A Journey Through Time.....	Page 1
Imam Ali (pbuh) Ameerul Mu'meen - Ruler of the Believers.....	Page 4
Imam Hasan (pbuh) Al-Mujtaba - The Chosen One...	Page 13
Imam Husayn (pbuh) Ash-Shaheed - The Martyr.....	Page 23
Imam Ali Zaynul Aabideen (pbuh) - The Best of Those Who Serve Allah.....	Page 34
Imam Muhammad Al-Baqirul Uloom (pbuh) - One Who Split Open Knowledge.....	Page 45
Imam Ja-fer As-Sadiq (pbuh) - The truthful One.....	Page 52
Imam Musa Al-Kadhim (pbuh) - The One Who Swallows His Anger.....	Page 62
Imam Ali Ar-Ridha (pbuh) - The Accepted One.....	Page 69
Imam Muhammad At-Taqi (pbuh) - The Pious One.....	Page 75
Imam Ali An-Naqi Al-Haadi (pbuh) - The pure One, The Guide.....	Page 85
Imam Hasan Al-Askery (pbuh).....	Page 95
Imam Muhammad Al-Mahdi (pbuh) - The Guided One.....	Page 102

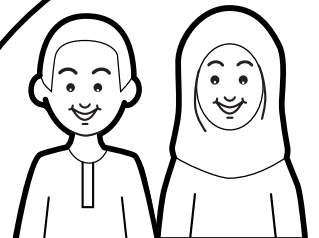

A JOURNEY THROUGH TIME

After the wafat of the Prophet (pbuh), whenever there was a query the companions acted according to the **Qur'an** and the **Sunna** of the Prophet (pbuh). Whenever they met new problems, they referred them to Imam Ali (pbuh) was the gate to the Prophet's Knowledge. (Babul 'Ilm)

"I am the city of knowledge and Ali is its gate"

Prophet Muhammad (pbuh)

During this time, the ahadith of the Prophet (pbuh) and the general customs of the Prophet (pbuh) were the most important basis of legislation after the Qur'an. As the Qur'an states:

"...What the Prophet gives you take! And refrain from what he prohibits you from....."

Suratul Hashr - 59:7

After the shahadat of Imam Ali (pbuh), Imam Hasan & Husayn (pbuh), one after the other became the Aimma. The 'Islamic government' at that time, however, was unfortunately in a unfortunate state, The Aimma had no opportunity to be in contact with the Muslims as a whole or even their own followers. They had to rise against the tyranny and oppression, and were only able to explain the laws to their immediate followers.

Imam Ali Zaynul Aabedeem (pbuh) was subjected to strict limitations. He explained shari'a, akhlaq, morals, and even political matters in the form of duas. The collection of these duas is called Sahifa Al-

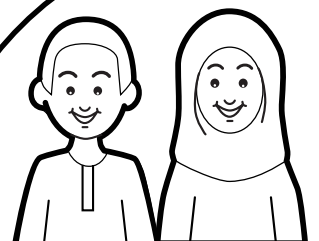

Sajjadiyya. A treatise of rights has also been written by Imam Ali Zaynul Abedeen (pbuh) called Risalatul Huquq.

At the time of Imam Muhammad Al-Baqir (pbuh), the rulers- Bani Umayya were constantly fighting with the Bani Abbas. Engrossed in their disputes, it provided Imam Muhammad Al-Baqir (pbuh) the conditions to be able to teach and inform people and scholars about the laws of Islam.

In the period of Imam Ja'fer As-Sadiq (pbuh), the anrchy of the Bani Umayya reached its climax, and he took advantage of the period to teach and spread knowledge. It is said that 4,000 students benefitted from Imam and they compiled nearly 400 books about various subjects from his sayings and lessons.

Imam Musa Al-Kadhim (pbuh) was subjected to severe oppression by the leadership, spending 19 years of his life in prison. However, this concentration on Imam gave relief to his followers who dispersed from Arabia to Iran, India, and Thus spreading Islam. The responsibility of guidance was delegated to the close companions of Imam.

In the time of Imam Ali Ridha (pbuh) there were many movements in the field of culture and learning, but with the transferrance of Imam to Mash'had, Iran, the freedom of propogating decreased.

Imam Muhammad At-Taqi (pbuh) was poisoned at the age of 25 years and was subject to severe restrictions.

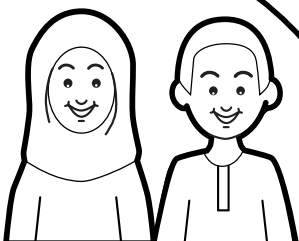

Imam Ali An-Naqi (pbuh) was transferred from his home in Madina to Samarra and the limitations upon Imam Hasan Askeri (pbuh) were such that he spent virtually all his life in imprisonment.

During these times, the students of these Aimmah were able to answer questions, and spread the ahadith and knowledge secretly.

After Imam Hasan Al-Askari (pbuh), the Imam of our time, Imam Muhammad Al-Mahdi (pbuh) solved problems and difficulties through 4 appointed representatives. These were:

1. Uthman bin Saeed (A.R.)
2. Muhammad bin Uthman (A.R.)
3. Husayn bin Rawh (A.R.)
4. Ali bin Muhammad Samry (A.R.)

GHAYBAT E KUBRA

The appointed representatives were no more, and the role of guiding the Muslims,

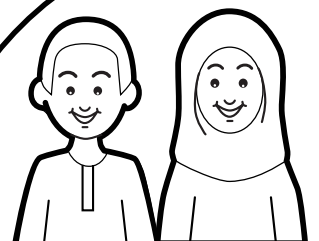

IMAM ALI (pbuh)

AMEERUL MU'MINEEN - RULER OF THE BELIEVERS

He was born in the Ka'ba in Makka on the 13th of Rajab - the year 30 'Aamul Feel.

His father was called 'Imran but is better known as Hazrat Abu Talib (pbuh)

His mother was Sayyida Fatima binte 'Asad (pbuh)

He was a very brave man and the hero of all the battles of Islam. He had a special sword called Zulfikar.

He was very clever. The Prophet (pbuh) said:
"I am the city of knowledge, and Ali is its gate"

When Imam Ali (pbuh) was 22 years old, the Prophet (pbuh) went from Makka to Madina because the bad people of Makka wanted to kill him. Imam Ali (pbuh) slept in the Prophet's bed so that the bad people would not know that he had left.

He married the Prophet's daughter - Sayyida Fatima Az-Zahra (pbuh) and they had five children.

The Prophet (pbuh) on Allah's command had chosen Imam Ali (pbuh) as the leader (Imam) of the Muslims after him.

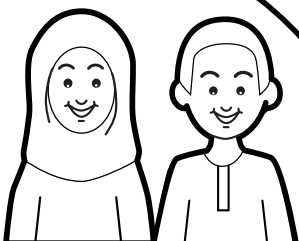

On the 19th of Ramadhan 40 A.H. in the masjid of Kufa a bad man called Abdur Rahman ibn Muljim hit him on the head with a poisonous sword. Imam Ali (pbuh) died two days later.

He is buried in Najaf (Iraq).

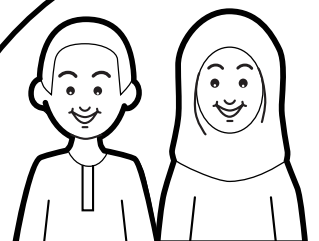

IMAM ALI (pbuh) AMEERUL MU'MINEEN - RULER OF THE BELIEVERS

إِنَّمَا وَلِيُّكُمُ اللَّهُ وَرَسُولُهُ وَالَّذِينَ آمَنُوا الَّذِينَ يُقِيمُونَ الصَّلَاةَ وَيُؤْتُونَ الزَّكَاةَ
وَهُمْ رَاكِعُونَ

“Indeed, your wali is only Allah and His messenger and those who believe - those who establish salaa and pay the zakaa whilst in rukoo.

Qur'an - Suratul Ma'ida - 5:55

All Muslim scholars agree that this aya was revealed in honour of Imam Ali (pbuh).

Wila, Wilaya. Wali, mawla - The original meaning of all these words comes from the root word - *waliya*. It is used to describe nearness, closeness, special or spiritual affinity, obedience, mastership and authority.

In the aya above *wilaya* refers to obedience with love. It clearly shows that there are only 3 awliyyaa (plural of wali) of those who believe:

1. Allah
2. His Prophet (pbuh) - Nabuwwa
3. Imam Ali (pbuh) - Imama

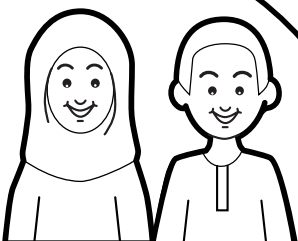

Abu Dharr Ghifari (A.R.) says that one day he was praying with the Prophet (pbuh) in Masjidun Nabi when a beggar came to the masjid. Everyone was praying and no-one responded to his pleas for help. The beggar raised his hands and said: "O Allah! Bear witness that I came to Your Prophet's masjid and no one gave me anything." Imam Ali (pbuh) was in rukoo. He stretched his hand towards the beggar and pointed out his little finger on which was a ring. The beggar came forward and took the ring.

The Prophet (pbuh) raised his face towards the heavens in dua: "Ya Rabbi! My brother - Prophet Musa (pbuh) begged to You to expand for him his breast, make his work easy for him and loosen the knot on his tongue so that people might understand him, and to appoint from amongst his relations his brother as his wazir and to strengthen his back with Harun and to make Harun his partner in work (Suratu Taha 20:25-30).

Allah! You said to Musa: 'We will strengthen your arm with your brother ...' O Allah! I am MuhammadExpand my breast for me, make my work easy for me and from my family appoint my brother Ali as my wazir. Strengthen my back with him." The Prophet (pbuh) had not yet finished his dua when Jibrail brought the above aya of the Qur'an.

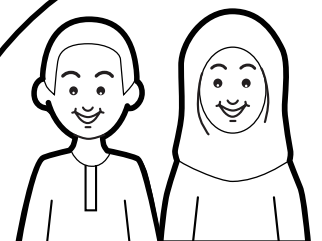

IMAM ALI (pbuh) GETS THE BEST SLEEP!

In the time of the Prophet (pbuh) the idol worshippers of Makka were very angry with him. They wanted to kill him.

Allah had told the Prophet (pbuh) about the plan of the idol worshippers to murder him and so he decided to move to Madina.

The idol worshippers chose 40 of their bravest men and told them to go to the Prophet's (pbuh) house and kill him.

That night the Prophet (pbuh) left for Madina, but before he left he asked Imam Ali (pbuh) if he would sleep in his bed so that the idol worshippers outside would think that he, the Prophet (pbuh) was there.

Imam Ali (pbuh) was very happy to do this for the Prophet (pbuh). In fact Imam Ali (pbuh) said that the best sleep that he had ever had was on that night.

When the killers came into the Prophet's (pbuh) house and pulled off the blanket they saw Imam Ali (pbuh) there, and so they left angrily.

Moral:

1. When you do something purely for Islam, then Allah helps you.
2. Everyone can plan but only what Allah wants will happen.



Answer the Following Questions:

1. Who slept in the Prophet's (pbuh) bed on the night of Hijra?

2. Why was the night of Hijra the most peaceful night that Imam Ali (pbuh) had ever had?

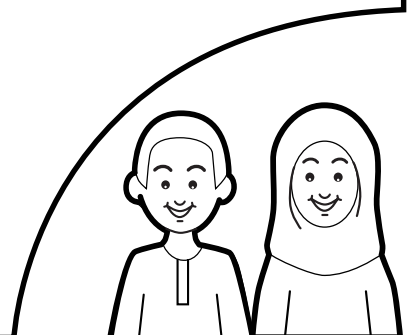

Family Tree of Imam Ali (pbuh)

Fill in the blanks of the family tree.

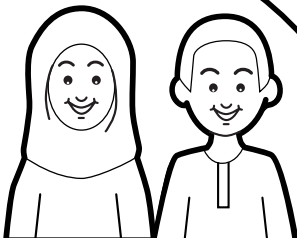
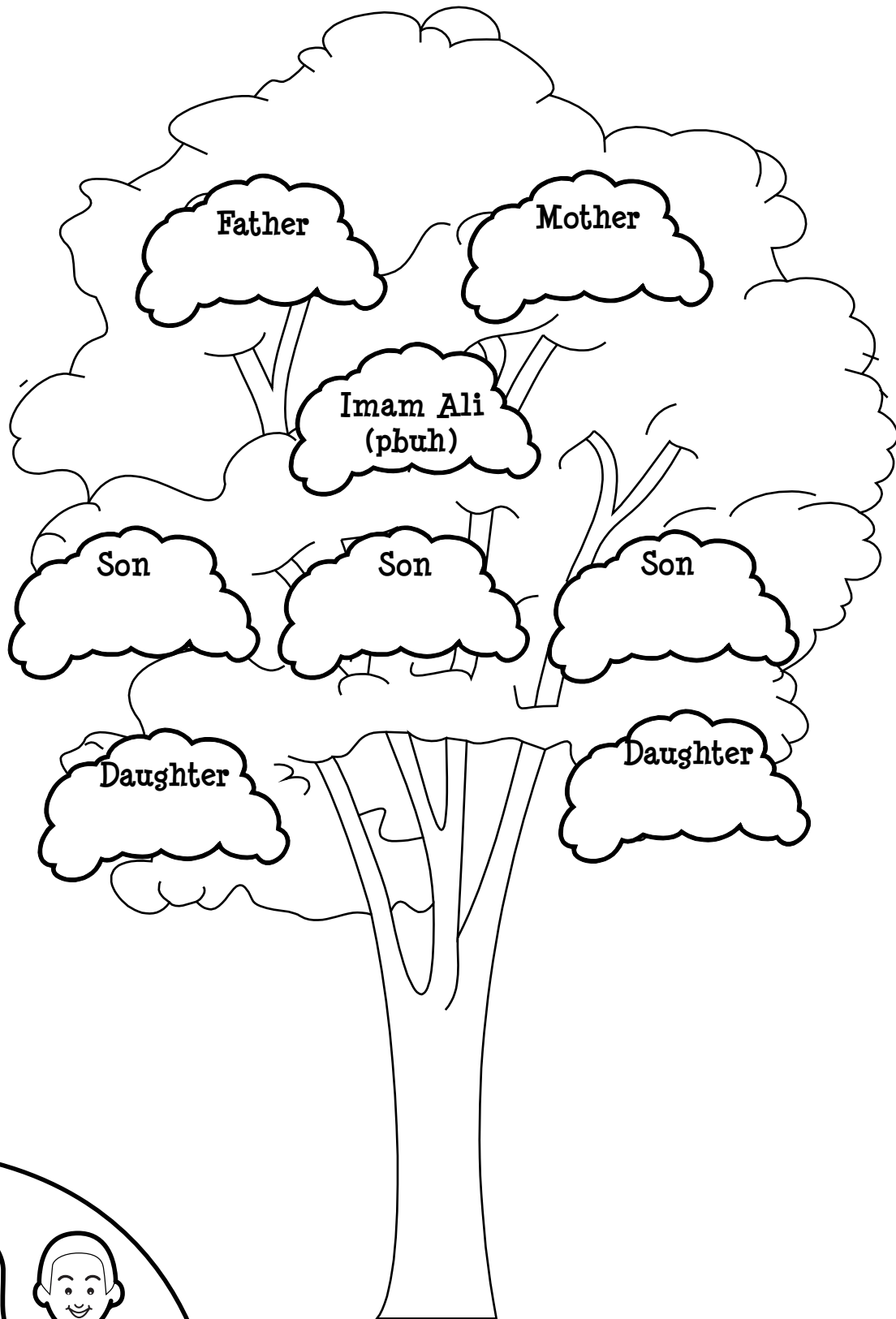

Activity Sheet - Imam Ali (pbuh)

Match the columns

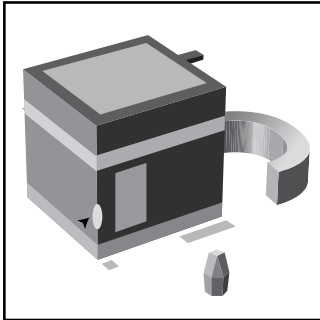

Asadullah which means
..... of Allah

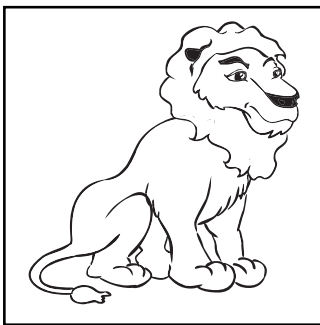

He was born here

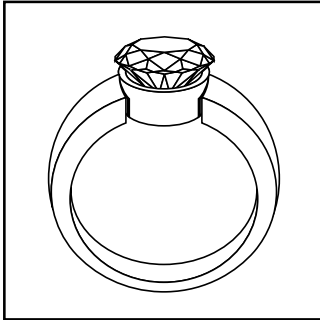

Zulfikar

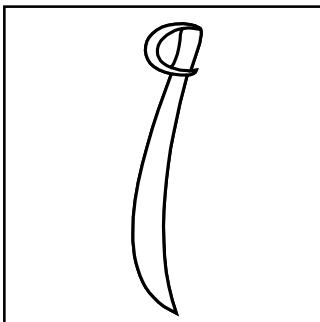

He gave this in ruku
to a poor man

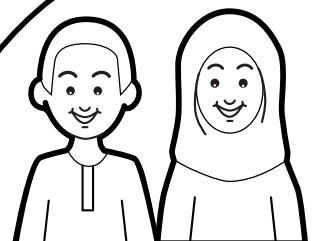

I Know my Imam...

My first Imam

Full Name:

Father's Name:

Mother's Name:

Date of Birth:

Place of Birth:

Children and Names:

.....

.....

Date of Death:

Burial Site:

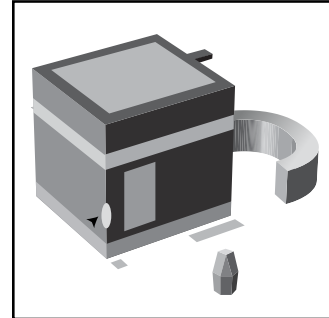

Born in the Ka'ba

One Hadith / Saying:

Another Hadith / Saying:

The Ma'sum who:

(write one specific aspect of his life by which you can remember him).

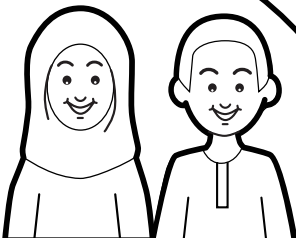

IMAM HASAN (pbuh)

AL-MUJTABA - THE CHOSEN ONE

He was born in Madina on the 15th of Ramadhan 3 A.H.

His father is Imam Ali (pbuh) and his mother is Sayyida Fatima Az-Zahra (pbuh)

He is the first grandchild of the Prophet (pbuh). When the Prophet (pbuh) heard of the birth of Imam Hasan (pbuh) he was very happy.

When Imam Hasan (pbuh) was 7 days old, the Prophet (pbuh) arranged for his hair to be shaved off. The hair was then weighed against silver which was then given to the poor. An animal was also sacrificed. The Prophet (pbuh) also arranged for a feast for all the people of Madina. This ceremony is called 'aqeeqa'.

When Imam Hasan (pbuh) was older, he always went to listen to the lectures of the Prophet (pbuh) in the Masjid. When he came home from the masjid his mother would ask him about the lecture, and he would relate to her whatever the Prophet (pbuh) had said.

Whenever he went to do wudhoo, he used to tremble and his face went pale. When he was asked why - he answered:

“Do you not know that I am standing in front of Allah?”

There was a bad man called Muawiyah who said bad things about Imam Hasan (pbuh). He also paid people to be the enemies of Imam



Hasan (pbuh). He even gave money to Imam Hasan's wife so that she would poison him.

Imam died of the poison that his wife Juhda gave him.

He died on the 7th of Safar 50A.H.

He is buried in Jannatul Bagee in Madina.

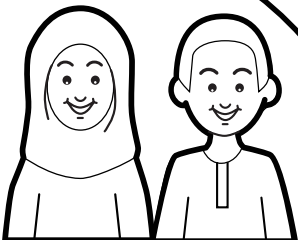

IMAM HASAN (pbuh) AL-MUJTABA - THE CHOSEN ONE

أَنعَمَ اللَّهُ عَلَيْهِمْ مِنَ النَّبِيِّينَ مِنْ ذُرِّيَّةِ آدَمَ وَ مِمَّنْ حَمَلْنَا مَعَ نُوحٍ
أُولَئِكَ الَّذِينَ
بُرَاهِيمَ وَ إِسْرَائِيلَ وَ مِمَّنْ هَدَيْنَا وَ اجْتَبَيْنَا ط إِذَا تُتْلَى عَلَيْهِمْ آيَاتُ
وَ مِنْ ذُرِّيَّةِ
الرَّحْمَنِ خَرُّوا سُجَّدًا وَبُكِيًّا

“These are those on whom Allah bestowed His ne’ma from among the Prophets from the children of Adam, and of those who were carried (on the Ark) with Nuh, and from the progeny of Ibraheem and Israeel (Yaqub), and from those whom We guided and **chose**; when the signs of the Merciful are recited to them, they fall in sajda weeping.” **19:58**

Whenever Imam Hasan (pbuh) stood for wudhoo, he trembled and his face went pale. When asked why? He would say "Don't you know I am standing in front of my Creator?" Whenever he was reciting Qur'an and came across an ayah beginning with "O you who believe..." He would immediately answer back "Labbaik, Allahumma Labbaik". (I am here, O Allah, I am here!!) People used to throng outside his house to hear him reciting Qur'an, so much so that the road would get blocked.

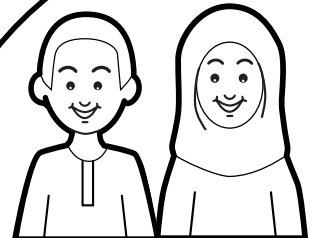

Once when one of his servants spilt hot food over him, Imam recited the aya of Suratu Aali Imran (3:134) "And those who swallow anger..... (Imam smiled - no anger) and forgive men..... (Imam forgave him) and Allah loves the doers of good..... (Imam freed him from slavery).

A man from Syria came to Madina and started abusing Imam Ali (pbuh) Imam Hasan (pbuh) told him that as he (the man) had just arrived from a long journey he had better first eat and rest. He could talk later.

After that the man told Imam "I arrived in Madina as your worst enemy and now I am the best of your admirers through your character".

Hasan bin Yasar (Bashari) was a famous scholar of Islam and a man of wisdom (21 A.H. -110 A.H. He saw Imam Ali (pbuh) to Imam Sadiq (pbuh)). He did not believe that man had free will. One day he had second thoughts and wrote to Imam Hasan (pbuh): "Bismillahirrahmaanirraheem. O son of Hashim, O son of Ali, you are the ark of Nuh, whoever comes to it is saved and whoever leaves it is drowned. What do you say of man's actions? Are they controlled by Allah or by himself?"

Imam replied: "O Hasan bin Yasar, remember! These hands, legs, tongue and body are given to you by Allah. He equips you and makes you their custodian to use the equipment for its proper particular use".

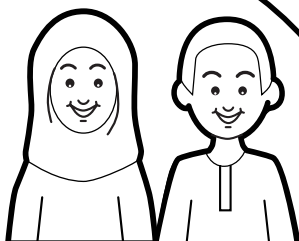

Allah is the proprietor and the human being a lease holder. LOVE OF ALLAH

Love of Allah has to be shown through our actions and akhlaq.

Think of an invisible chain that binds you to Allah.

Cut out strips of sugar paper and make chain writing on each one that brings you closer to Allah and demonstrates your love for Allah.

Here are a few to start you off....

Obedience, truthfulness, niyya, farness from sins, knowledge, good akhlaq.....

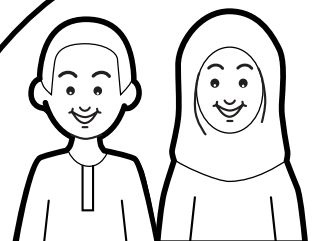

IMAM HASAN (pbuh) FORGIVES THE MAID



Once a maid of our 2nd Imam, Imam Hasan (pbuh) dropped a hot bowl of soup on Imam (pbuh).

She was very scared because she thought the Imam (pbuh) would be angry and punish her.

She immediately recited the Ayah:
“..Those who control (their) anger...”

Imam Hasan (pbuh) smiled and said he was not angry.

Then she recited the next part of the Ayah:
“..And are forgiving towards people...”

Imam Hasan (pbuh) said he had forgiven her.

She then finished the Ayah :
“..Allah loves those who do good...”
Imam Hasan (pbuh) told her she was free.

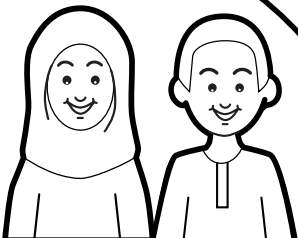

The above Ayah is from the Holy Qur'an:
Surah Aali Imraan (3), verse 134.

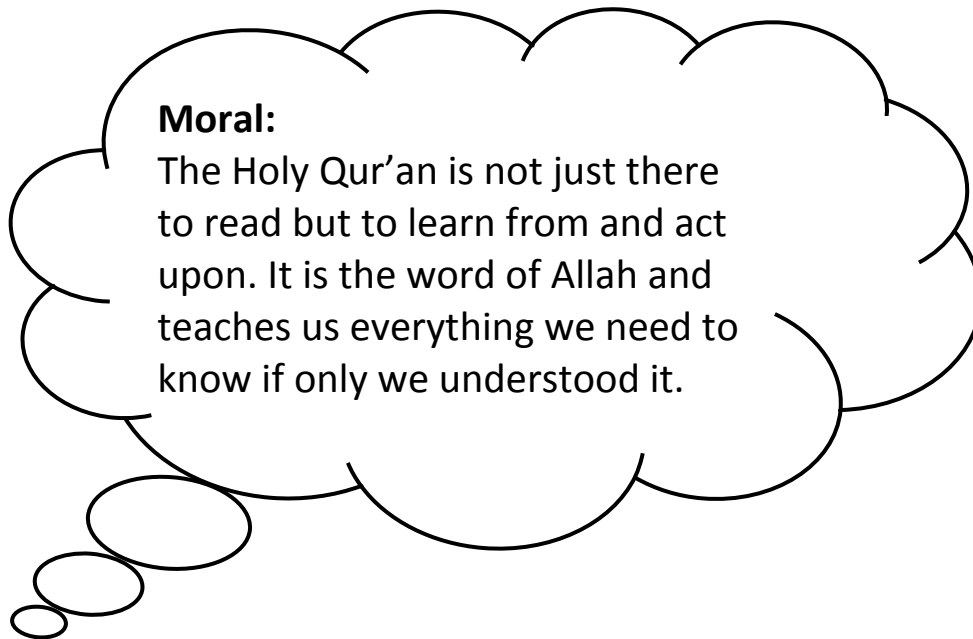

ANSWER THE FOLLOWING QUESTIONS:

1. Why did Imam Hasan (pbuh) act upon the verses that the maid recited?

2. What do you learn from the Qur'an?

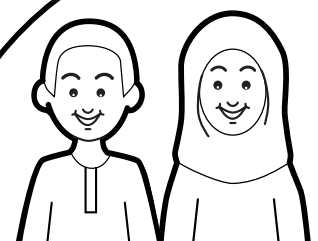

Activity:

Qur'an is not there only to be read but also to be applied in our life.

Colour the picture below of children reading the Qur'an.

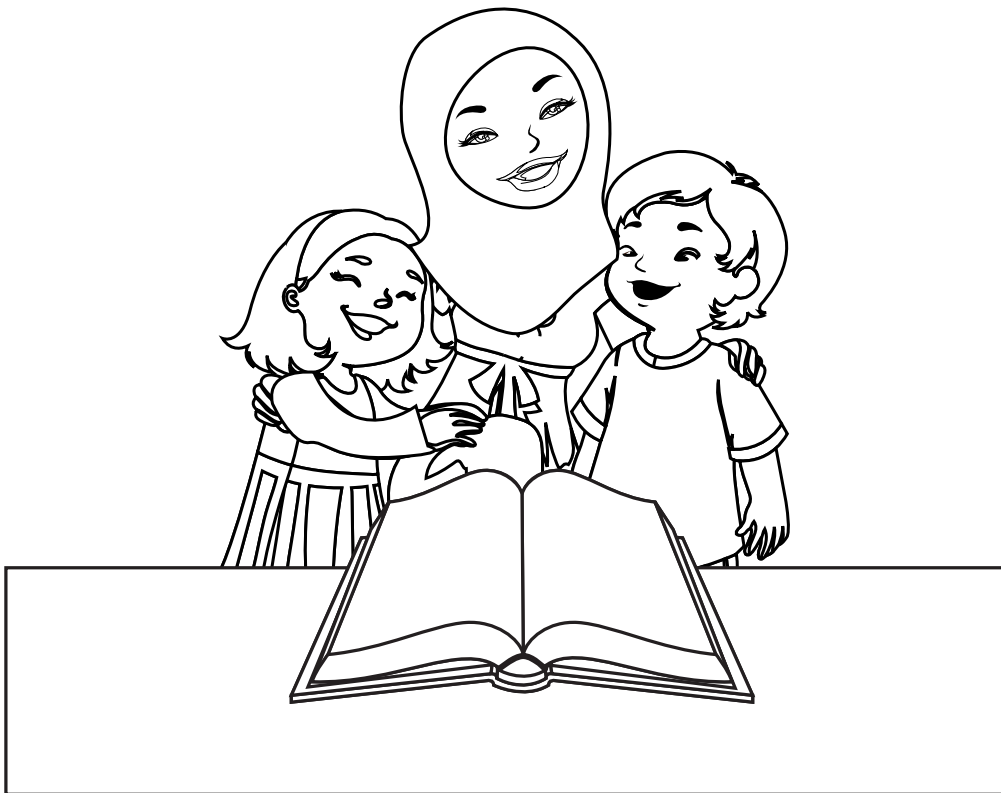

Ask your parents if they can help you find a verse of a Surah that you know or recite often which you can act upon. Ask them to help you write the meaning of that verse in the box below.



Imam Hasan (pbuh)

Fold a piece of card and draw a heart on the front cover.
Write Imam Hasan (pbuh) on it. Colour and decorate the heart.

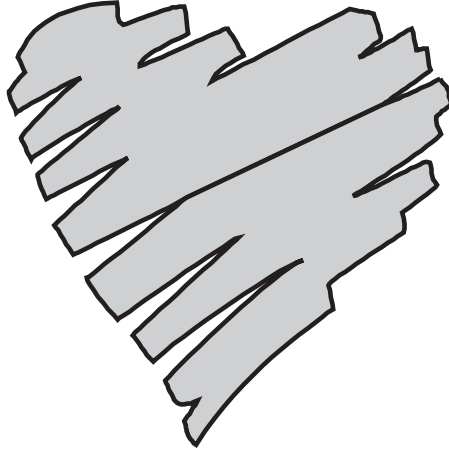

Write a greeting inside the card.
e.g.

In Hadithe Kisaa, Sayyida
Fatima Zahra (pbuh)
addressed her son Imam
Hasan (pbuh) as “Thamarata
fuaadiy” - Dlight of my heart

To,
My dearest Mummy & Papa,

On this day I promise that I
Will try my best to follow the
teachings of my Imam and I
hope always to remain your
thamarata fuaadiy.

Lots & Lots of Love & Duas

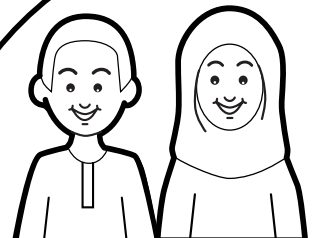

I Know my Imam...

My second Imam

Full Name:

Father's Name:

Mother's Name:

Date of Birth:

Place of Birth:

Children and Names:

.....

.....

Date of Death:

Burial Site:

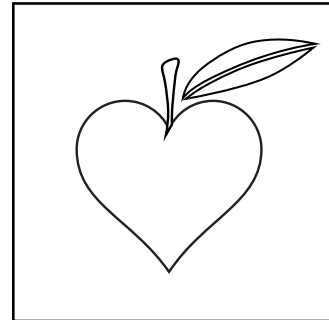

The apple of his
mother's heart

One Hadith / Saying:

Another Hadith / Saying:

The Ma'sum who:

.....
(write one specific aspect of his life by which you can remember him).

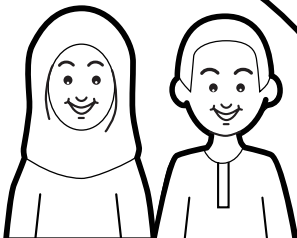

IMAM HUSAYN (pbuh) ASH-SHAHEED - THE MARTYR

Imam Husayn (pbuh) was born in Madina on the 3rd of Sha'ban 4 A.H.

His parents are Imam Ali (pbuh) and Sayyida Fatima Az-Zahra (pbuh). On the day he was born, Allah told the angel Jibraail to go and congratulate the Prophet (pbuh), Imam Ali (pbuh) and Sayyida Fatima Az-Zahra (pbuh). On the way down from the heavens, Jibraail passed an island where the angel Fitrus was banished to (as a punishment for taking too long in doing something Allah had ordered him to do). His wings had also been taken away.

“Where are you going, Jibraail?” Fitrus asked.

Jibraail told him he was going to congratulate the Prophet (pbuh) and his family on the birth of Imam Husayn (pbuh)

“Can I come with you?” Fitrus asked

With Allah's permission, Jibraail took Fitrus with him. They congratulated the Prophet (pbuh). The Prophet (pbuh) asked Fitrus to touch the cradle of Imam Husayn (pbuh). As soon as he touched the cradle, with the permission of Allah his wings were restored. He thanked the Prophet (pbuh) When Fitrus returned to the heavens; all the other angels asked him what perfume he had used because there was a fragrance coming from him. Fitrus replied:

“I am the lucky one who has touched the cradle of Imam Husayn (pbuh).”

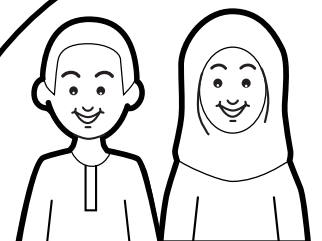

Prophet Muhammad (pbuh) loved Imam Husayn (pbuh) and he said that there would come a day when Imam Husayn (pbuh) would save Islam.

Yazid was an evil man who became the ruler of the Muslims. He tried to change everything that the Prophet (pbuh) had taught. He even dressed monkeys like 'ulema (learned people) and sat them on the mimbar of the Prophet (pbuh). He killed anyone who did not obey him. Yazid wanted Imam Husayn (pbuh) to promise to obey and follow him. When Imam refused, he became very angry.

Yazid got a large army together and surrounded Imam Husayn (pbuh) and his family and friends in Karbala.

On the day of 'Ashura 61 A.H., Imam Husayn (pbuh), his friends and male family members including baby Ali Asgher who was 6 months old were killed. The women, children and Imam Ali Zayn ul Aabedeen (pbuh) who was ill were taken prisoners.

Imam Husayn (pbuh) and the other shuhada (martyrs - those killed in the way of Allah) are buried in Karbala.

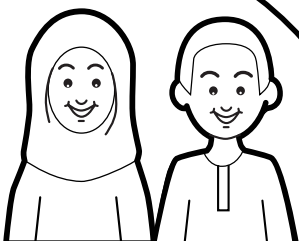

IMAM HUSAYN (pbuh) ASH-SHAHEED - THE MARTYR

الَّذِينَ قُتِلُوا فِي سَبِيلِ اللَّهِ أَمْوَاتًا ط بَلْ أَحْيَاءٌ عِنْدَ رَبِّهِمْ يُرْزَقُونَ
وَلَا تَحْسَبَنَّ

"Do not think of those who have been killed in the way of Allah as dead; Nay! They are alive with their Rabb - given sustenance."

Suratu Aali Imran - 3:169

"If this world be considered a treasure;
A reward far worthy is gaining Allah's pleasure.
If all we possess must be left behind,
Then why should mankind hold on to that which must be abandoned.
If sustenance is what is predestined,
Then lesser the greed to possess, the better it is.
If bodies have been created to die,
Then martyrdom (in the way of Allah) is the best."

Imam Husayn (pbuh)

A martyr is one who has sacrificed his life to achieve a sacred cause and especially if the sacrifice is made willingly and consciously. It is the only type of death which is higher, greater and holier than life itself.

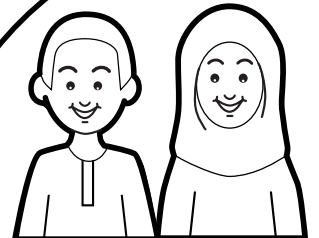

The sacred cause that leads to martyrdom has become a law in Islam. It is called jihad. A Mujahid (one who does Jihad) sacrifices his life to save his society and surrenders himself totally to Allah.

Every drop of a martyr's blood is turned into a thousand drops which are transfused into the body of his society. Especially a weak society giving it strength and reviving it.

A martyr can be compared to a candle whose function is to burn and get extinguished in order to give light for the benefit of others. Without the martyr's light no human organisation can shine for they are the candles of humanity.

The famous poet Iqbal wrote the following elegy in praise of Imam Husayn (pbuh):

He was the one who (by his shahadat) infused faith in the heart of the believers, The earth trembled whilst he lay in sajda to Allah, He was the one who said 'La Ilaha Illallah' whilst his head was being severed by a sword.

From his blood springs forth the belief that there is no God but Allah.

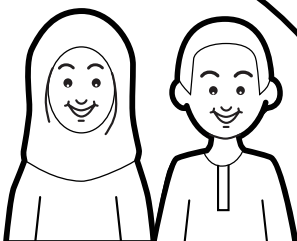

IMAM HASAN & HUSAYN (pbuh) SHOW US HOW TO TEACH

One day in Madina, an old man was performing his wudhu getting ready to say his prayers. By chance, both Imam Hasan (pbuh) and Imam Husayn (pbuh) who was also there, and they noticed that the old man was not performing the wudhu correctly.

Allah has asked us to correct people if they are not doing things correctly according to Islam. This duty is called **“Amr bil Ma’ruf”**. The Imams knew that they had to guide the old man about his mistakes.

However, the Imams were only young at the time, and they felt that the old man would be ashamed if he was corrected by young children.

Then the Imams had a wonderful idea on how to teach the man. They pretended to argue with one another. Imam Hasan (pbuh) said to his brother Imam Husayn (pbuh), “I think my wudhu is more correct than yours.” Imam Husayn (pbuh) replied, “No, I think my wudhu is more correct than yours.”

The old man was listening to their argument. Now Imam Hasan (pbuh) turned to him and said, “Dear sir, will you judge between my brother and I to see whose Wudhu is more correct?”

The old man agreed.

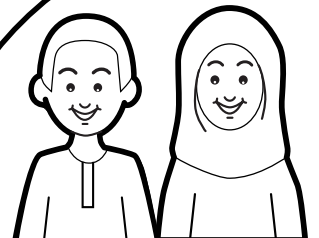

The two Imams both performed the wudhu, one after the other. The old man watched closely, and realized they were exactly the same!

He also realized that he was not performing the wudhu correctly himself. He knew that the children were trying to correct him in a very polite way.

He liked the children's good manners very much. He said, "My dear children, it is I who have been performing the wudhu incorrectly. Thank you so much for the nice way in which you guided me!"

Moral:

It is our duty to correct someone who is not doing something right. We must not just ignore them. However, when we guide them, we must not be rude or mean. We must do it in a friendly and polite manner, so they listen to us and are not upset

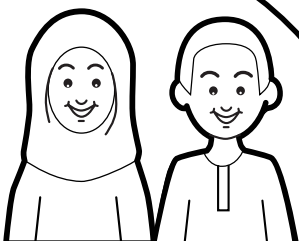

Do the following Activities:

1. Do you know how to perform the Wudhu correctly?
(Ask your parents to check your wudhu for you.)

2. Do the Activity Below:

Taha is trying to do wudhu but he has all the actions mixed up.

Put numbers in the circles besides each action in order that he can do his wudhu correctly.

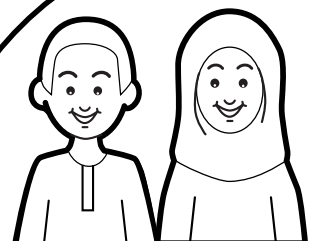
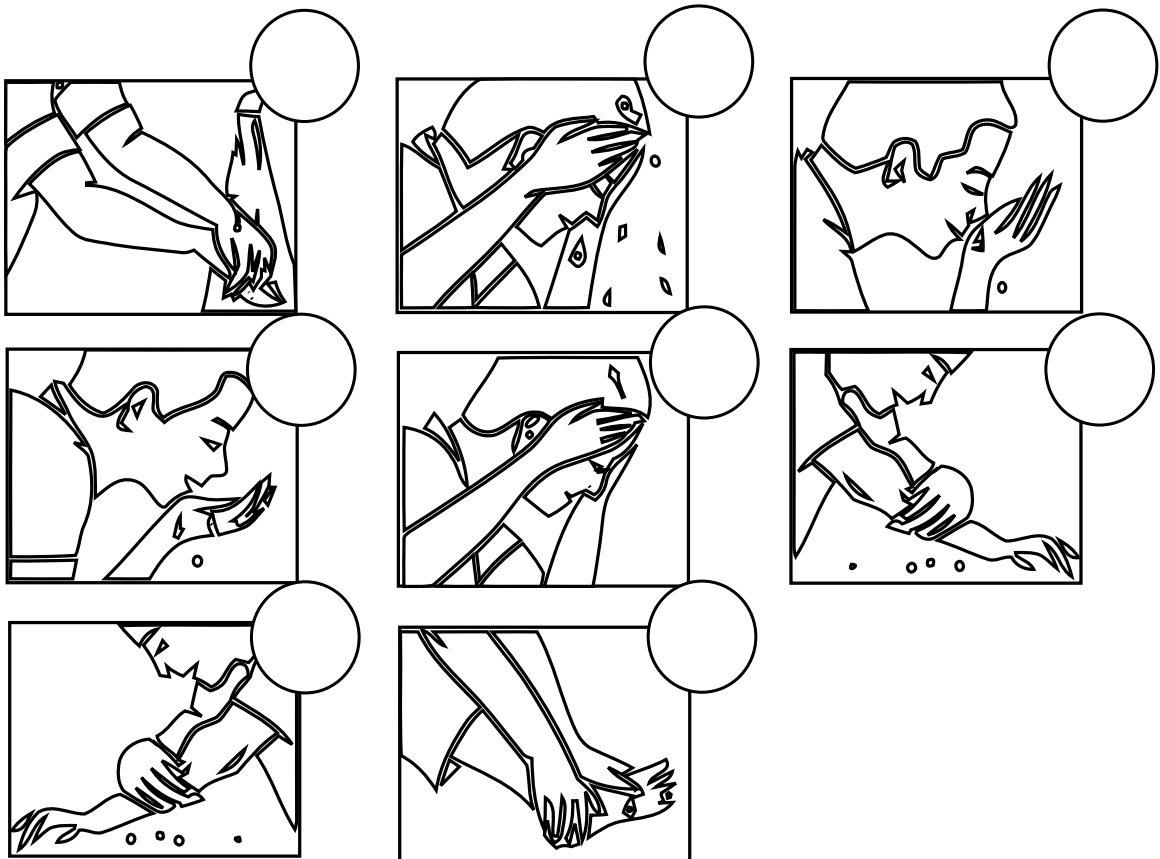

Imam Husayn (pbuh)

Draw a tablet of clay under the boys head.

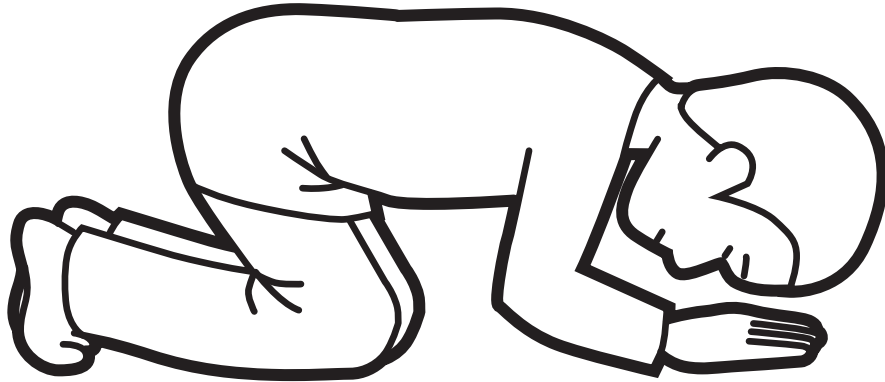

Khak e Shifa

Find where Kerbala is on the map and mark it on the map.

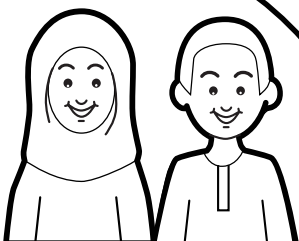

The Candle of Loyalty

Imam Husayn (pbuh) blew out a candle on the night of Ashura so that those who wanted to leave could do so.
None of his loyal companions left.

Write a list of the companions of Imam Husayn (pbuh) that you know:

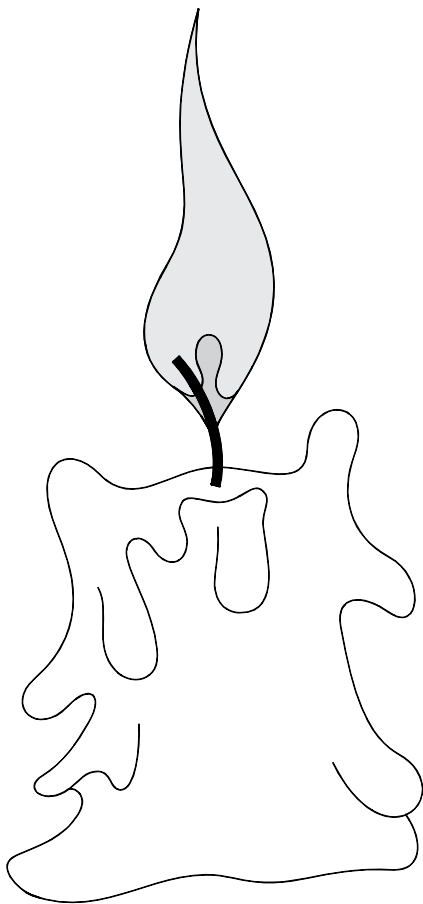

.....

.....

.....

.....

.....

.....

.....

.....

.....

.....

.....

.....

.....

.....

.....

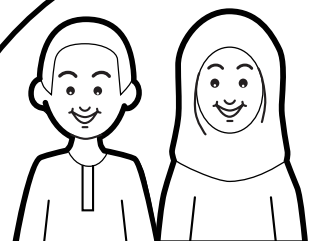

**“If this world be considered a
treasure, then a reward far better is
Allah’s pleasure...”
Imam Husayn (pbuh)**

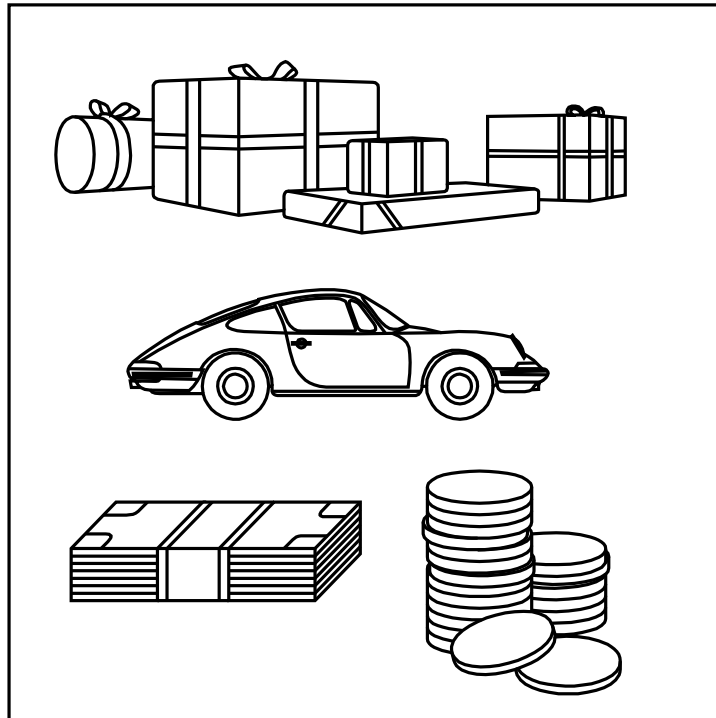

How would you use the things above to get Janna?



I Know my Imam...

My third Imam

Full Name:

Father's Name:

Mother's Name:

Date of Birth:

Place of Birth:

Children and Names:

.....

.....

Date of Death:

Burial Site:

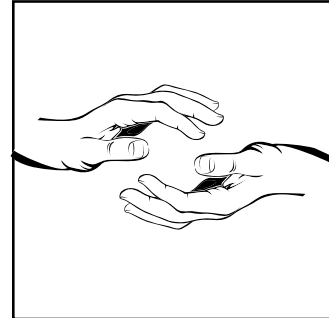

Did not give
Bay'at to Yazid

*Bay'at means
promising to
follow and obey

One Hadith / Saying:

Another Hadith / Saying:

The Ma'sum who:

.....
(write one specific aspect of his life by which you can remember him).

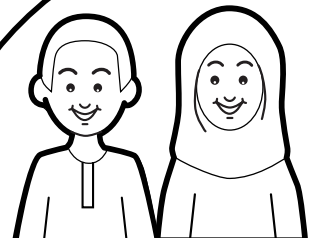

IMAM ALI ZAYNUL AABIDEEN (pbuh) THE BEST OF THOSE WHO SERVE ALLAH

Imam Ali Zaynul Aabideen (pbuh) was born in Madina on the 5th of Sha'ban 38 A.H.

His father is Imam Husayn (pbuh) and his mother was a princess from Iran. Her name was Sayyida Shahrbanu.

He was given the title 'Zaynul Aabideen' which means the 'best of worshippers'. He is also called 'Sayyidus Saajideen' meaning 'one who is the leader of those who do sijda'.

After the day of 'Ashura, when his father, uncles, cousins, brothers and friends were killed in Karbala, he was taken prisoner along with all the women and children of Ahlulbayt. He was tied in chains and a spiked collar was put around his neck. He was made to walk behind the camels which carried the women and children prisoners through towns and villages from Karbala to Kufa to Shaam (Damascus) where Yazid was.

Even though Imam was beaten and tied up, he told Yazid what a bad man he was and that Allah would punish him for his sins.

The prisoners including Imam Ali Zaynul Aabideen (pbuh) were put in a prison in Shaam which had no roof. It was very hot during the day with no shade from the sun and very cold at night with no blankets to keep them warm.

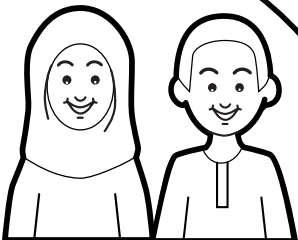

When he was freed from prison, Imam told everyone about Islam and standing up for the truth even if it means giving your life. He did this by holding and encouraging the majalis of Imam Husayn (pbuh). He also wrote a book of duas which is called 'Sahifatus Sajjadiyya' or 'Sahifatul Kamila'.

He was poisoned by the bad ruler Waleed and he died on the 25th of Muharram 95 A.H.

He is buried in Jannatul Baqee in Madina.

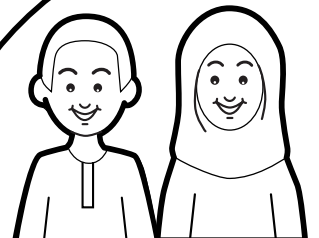

IMAM ALI ZAYNUL AABIDEEN (pbuh) THE BEST OF THOSE WHO SERVE ALLAH

أَيُّمَّةً يَهْدُونَ بِأَمْرِنَا وَأَوْحَيْنَا إِلَيْهِمْ فِعْلَ الْخَيْرَاتِ وَإِقَامَ الصَّلَاةِ وَ
وَجَعَلْنَاهُمْ
إِتْيَاءَ الزَّكَاةِ وَكَانُوا لَنَا عِبْدِينَ

“And We made them Aimmah, guiding by Our command, and We revealed to them the doing of good, the establishing of salaa and the giving of zakaa, and only Us do they serve. **Suratul Ambiya - 21:73**

‘Ubudiyya’ - servitude is a jewel whose centre is ‘Rububiyya’ - strength and power. In the Qur’an Allah has shown us the various stages through which to progress to achieve perfection at being an ‘abd’ - one who serves Allah. Allah has given the human being control of his/her nafs. The smallest sign of the acceptance of a human being’s deeds by Allah is that he/she becomes radiant and clear sighted.

“If you have taqwa for Allah, He will grant you a distinctive standard and remove from you all your sins, and forgive you, and Allah is the Lord of Mighty grace.” **Suratul Anfaal - 8:29**

The human being needs to strengthen his/her will power in order to be able to be an abd of Allah. It is only when one can break all other

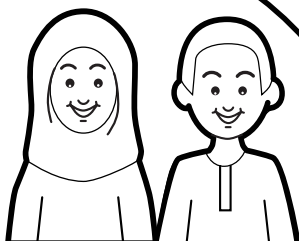

bonds (desires, material wants...) that one can become a true abid of Allah. There is nothing like worship whose foundation is concentration on Allah.

The Qur'an says:

Indeed Salaa keeps you away from indecency and dishonour..."

29:45

"O you who believe, siyaam (fasting) has been prescribed for you as it was prescribed for those before you so that you may have taqwa "

2:183

And about both forms of worship it says:

"O you who believe, seek help through patience* and salaa..."

2:153

*Here patience denotes fasting according to a hadith from the 6th Imam.

Imam's concentration and humility to Allah was such that when an arrow was removed from his foot during salaa he did not even flinch. The 5th Imam has said that his father was titled As-Sajjad because he did sajda whenever –

1. He received a blessing.
2. He finished any salaa.
3. Whenever he heard a Qur'anic verse of sajda.
4. When a difficulty was averted.
5. When he arranged peace between two people.

The mark for sajda was seen on all the 7 parts of his body which touch the ground during sajda...

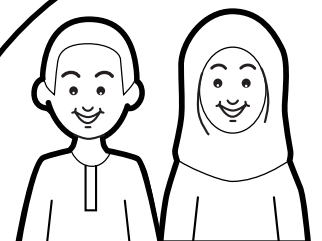

IMAM ALI ZAYNUL AABIDEEN (pbuh) TEACHES A LESSON!

Once a man who claimed to be a friend of our 4th Imam, Imam Ali Zaynul Aabideen (pbuh) came to him and told him that so and so had been saying horrible things about him.

Imam (pbuh) replied that he had not heard anything and would not have if the man had not told him. Imam (pbuh) then continued that the person who had said the horrible things was as if he had shot an arrow and missed the target but the man who had told him was as if he had picked up the fallen arrow and hit the target (Imam (pbuh)) with it.

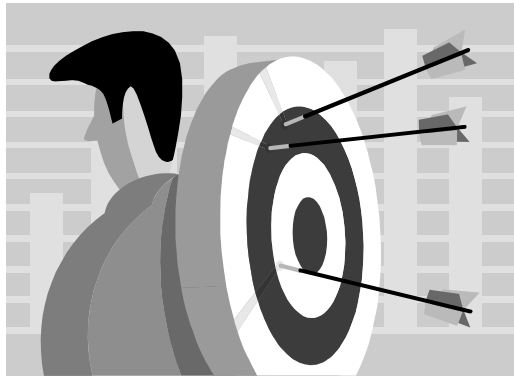

Allah does not like the habit of spreading scandal and gossip even if it be true.

Moral:

Do not talk about other people when they are not there even if what you say is true.

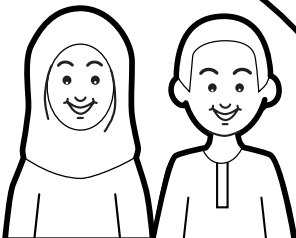

ANSWER THE FOLLOWING QUESTIONS:

1. Why did Imam Ali Zaynul Aabideen (pbuh) tell the man that by him telling Imam (pbuh) what the other person had said it was as if he had picked up the arrow and hit Imam (pbuh) with it?

2. If someone starts telling bad things about another person to you, what should you do?

Next time you are with a group of people and they start talking about someone who is not there (even if it is true) tell them not to, or walk away.

Do not stand there and listen, and NEVER tell anyone else (not even the person themselves) what was said.

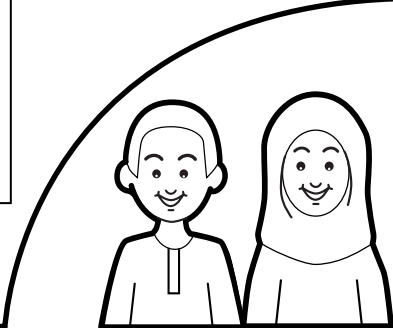

Activity:

In the hearts below write down names of 5 people you know.
Then write one good thing about them.

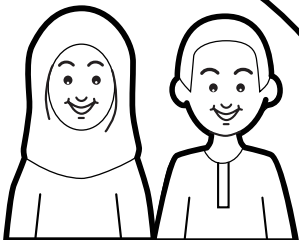
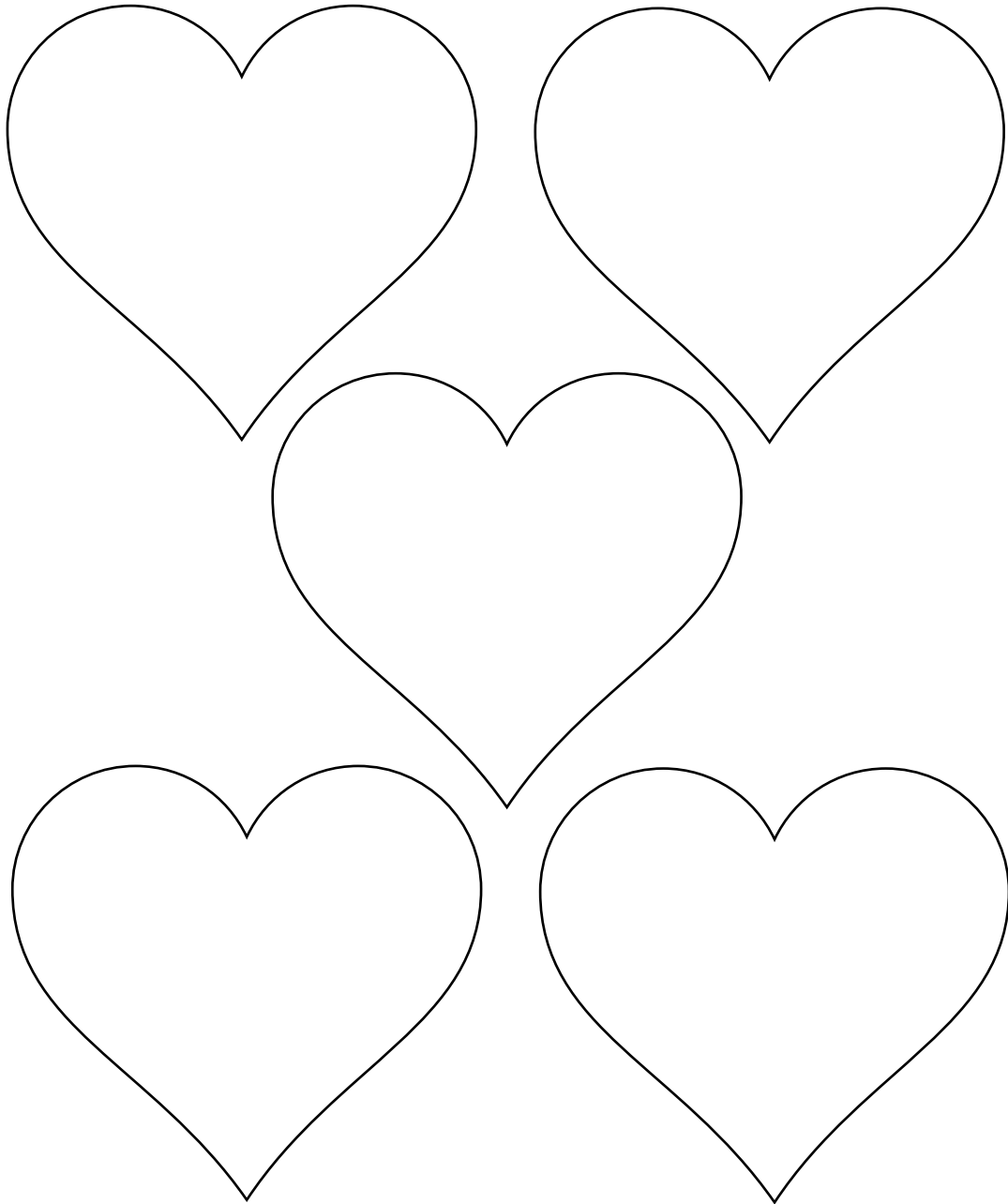

Sajda

Label and colour in the seven parts which must touch the ground during Sajda:

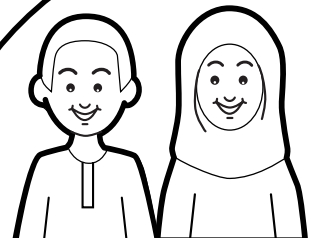
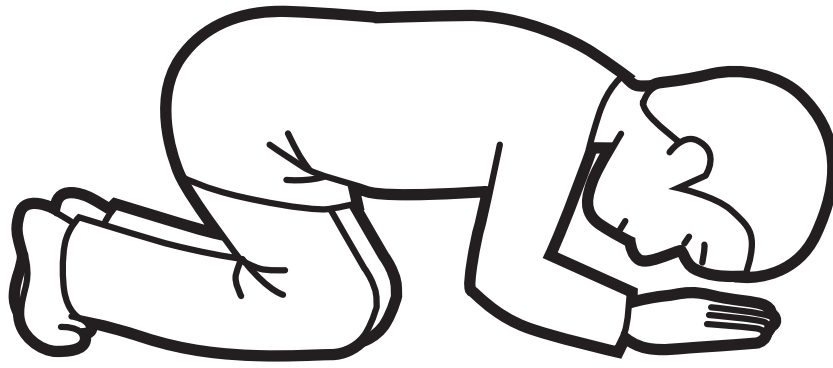

Imam Zaynul Abideen (pbuh)

Match the columns below:

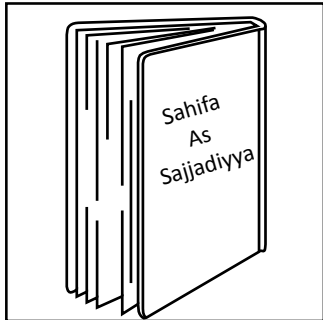

Father

Imam Husayn
(pbuh)

Mother

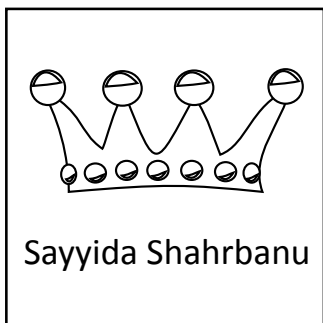

Title

Zaynul Abideen

Book of Duas
He wrote

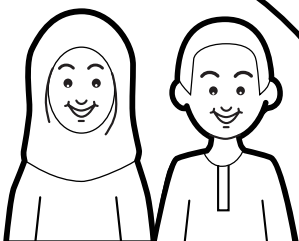

A Letter to My Parents

Dear Mum & Dad,

Assalamu Alaykum

I have learnt to say the best or keep quiet so I would like to say the best of words to you today. It is a dua for you from Sahifa As-Sajjadiyya by Imam Ali Zaynul Abedeen(A.S.)

"O Allah!

Thank them for bringing me up,
Reward them for honouring me,
And look after them as they looked after me
when I was little.....

Lots and Lots of Love and Duas

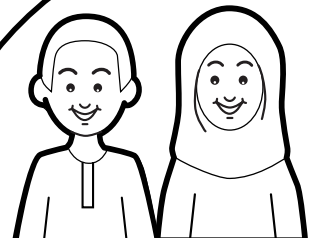

I Know my Imam...

My fourth Imam

Full Name:

Father's Name:

Mother's Name:

Date of Birth:

Place of Birth:

Children and Names:

.....

.....

Date of Death:

Burial Site:

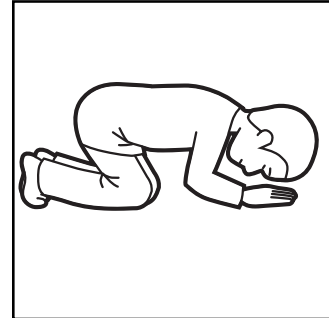

Sayyadus
Saajideen

One Hadith / Saying:

Another Hadith / Saying:

The Ma'sum who:

(write one specific aspect of his life by which you can remember him).

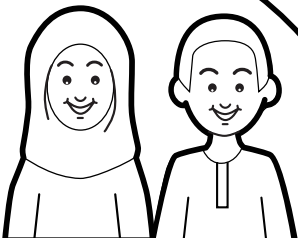

IMAM MUHAMMAD AL-BAQIRUL ULOOM (pbuh) ONE WHO SPLIT OPEN KNOWLEDGE

He was born in Madina on the 1st of Rajab 57 A.H.

His father is Imam Ali Zayn ul Aabideen (pbuh) and his mother was Sayyida Fatima bint Al-Hasan (pbuh) (She was the daughter of Imam Hasan (pbuh))

He was 3 years old in Karbala and was taken as prisoner with the women and children of the family of the Prophet (pbuh)

Imam was called Baqir al Uloom which means one who splits open knowledge, he taught many students.

He was the first to start writing books of Fiqh.

Although he was an Imam he still worked hard in the fields under the hot sun.

The ruler of the time wanted an idea of what to write on the coins of that country called Deenar which was the money of that time. Imam Muhammad Al-Baqir (pbuh) advised him to write:

لَا إِلَهَ إِلَّا اللَّهُ - 'There is no god except Allah' on one side and

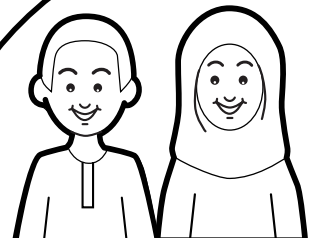

مُحَمَّدٌ رَسُولُ اللَّهِ - 'Muhammad is the messenger of Allah' on the other side.

The bad ruler of the time called Hisham sent Imam a poisoned saddle as a present. When Imam sat on it, the poison went into his body and he died on the 7th of Dhulhijja 114 A.H.

He is buried in Jannatul Baqee in Madina.

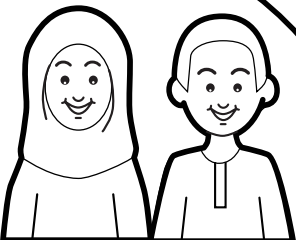

IMAM MUHAMMAD AL-BAQIRUL ULOOM (pbuh) ONE WHO SPLIT OPEN KNOWLEDGE

رَبِّ زِدْنِي عِلْمًا

“..O Lord! Increase my knowledge..”

Suratu Taha - 20:114

The human being is a thinking creature whose action is guided by his/her thoughts. Therefore, life is a mixture of action and knowledge. However, just as mixing hydrogen and oxygen on their own produces no reaction and thus no water unless a catalyst such as platinum is added, action and knowledge produce a perfect life when there is the catalyst of eemaan (faith).

The best of knowledge is that which makes one a better human being (one who serves Allah better).

In the Qur'an there are 704 ayaat in which the word 'ilm' or words of the same root are used. Seeking knowledge with eiman is a means of getting closer to Allah. (Refer to Ramadhan -3)

Imam Mohammed Baqir's (pbuh) main mission and message was knowledge.

He has said: “The ‘aalim whose knowledge is made use of is better than 70,000 worshippers.”

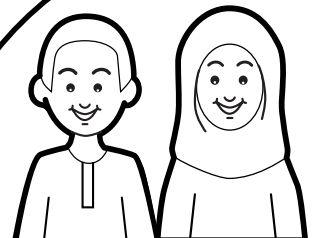

He encouraged his followers to acquire an Islamic character and to have excellent morals-akhlaq, and to disperse in the world for this was the best form of tableegh. He once told his companion Jabir bin Yazid Al-Jufi:

"There is no Shia who has no taqwa and no obedience to Allah" i.e. One cannot call oneself a Shia without these two qualities.

He continued and gave 12 signs of a Shia:

1. Humility,
2. Fear of Allah,
3. Trustworthiness,
4. Remembrance of Allah,
5. Fasts,
6. Prays salaa,
7. Goodness to parents,
8. Good to neighbours,
9. Responsible towards widows, orphans & children,
10. Fulfils his/her vows,
11. Pays back his/her debts,
12. Recites the Qur'an.



Knowledge...

How do you increase your knowledge?
Circle the answers

Madrasa

School

Watching
TV

Qur'an Classes

Parties

Majalis

Reading good
books

Reciting
Qur'an

Teaching

Observing
others

Computer
games

Shopping

Fighting

Discussing

Sleeping

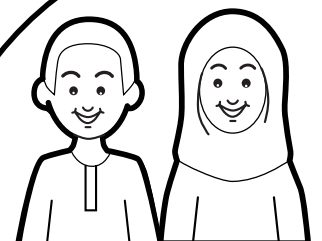

Imam Muhammad Al-Baqir (pbuh)

Colour the correct batteries which will produce the light of knowledge.

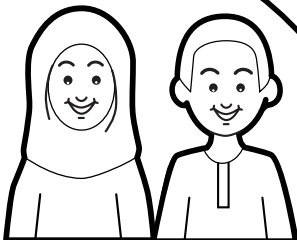
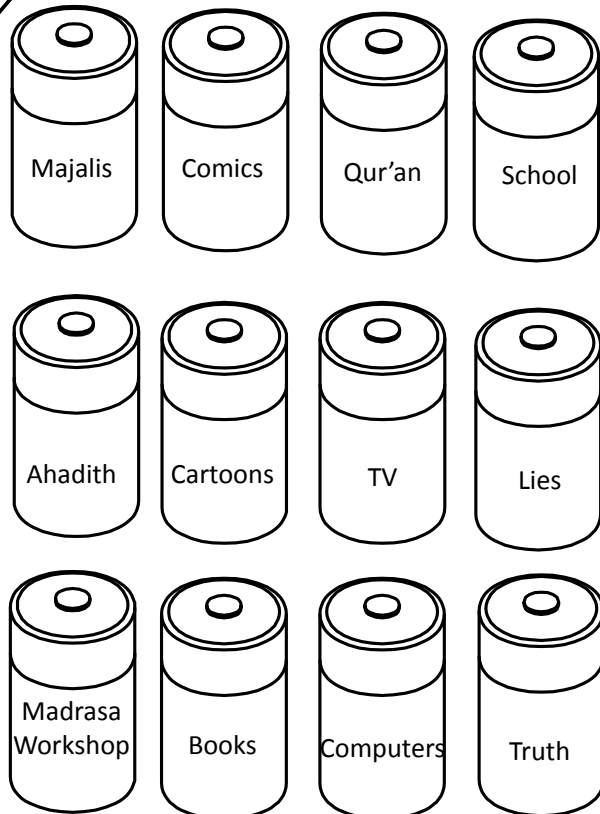
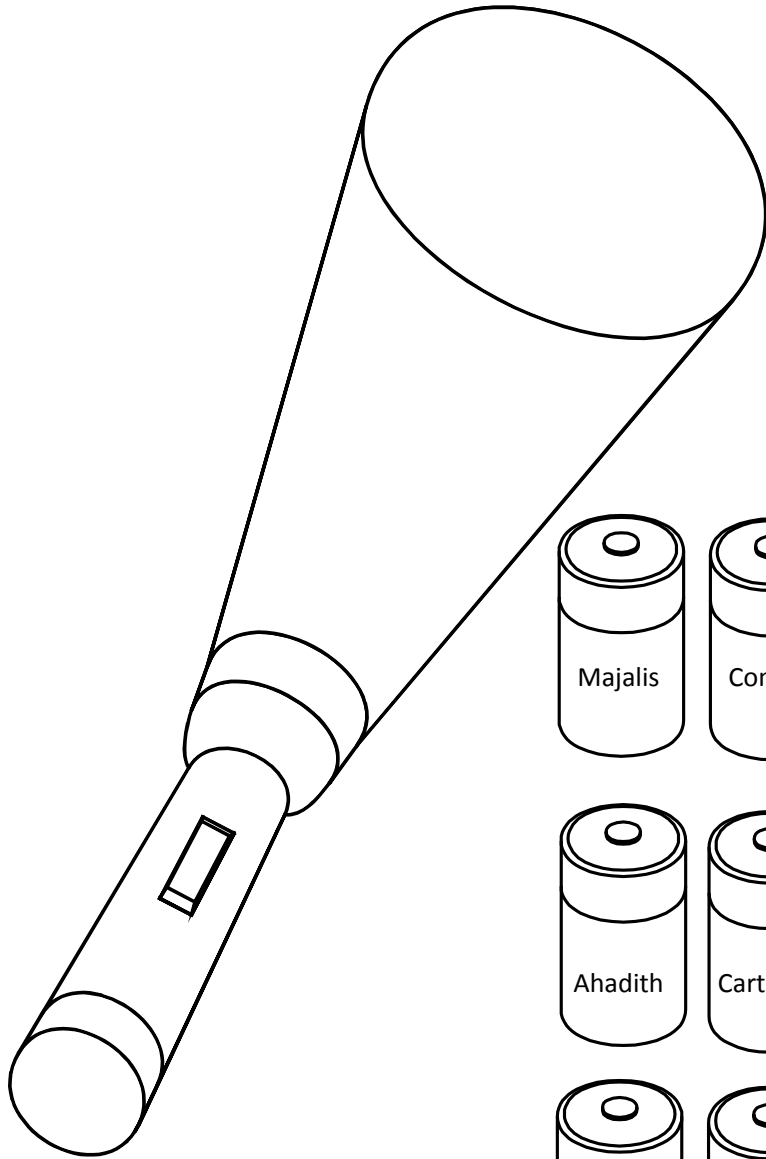

I Know my Imam...

My fifth Imam

Full Name:

Father's Name:

Mother's Name:

Date of Birth:

Place of Birth:

Children and Names:

.....

.....

Date of Death:

Burial Site:



Buried in Medina

One Hadith / Saying:

Another Hadith / Saying:

The Ma'sum who:

(write one specific aspect of his life by which you can remember him).

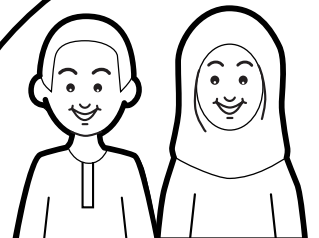

IMAM JA'FER AS-SADIQ (pbuh) THE TRUTHFUL ONE

Imam Ja'fer As-Sadiq (pbuh) was born in Madina on the 17th of Rabi ul Awwal 83 A.H. He has the same birth date as Prophet Muhammad (pbuh)

His father is Imam Muhammad Al-Baqir (pbuh) and his mother was Sayyida Fatima better known as Umme Farwa. She was a very clever lady who taught the laws of Islam.

After Imam Muhammad Al-Baqir (pbuh) was poisoned the bad rulers were busy fighting each other and this allowed Imam Ja'fer As-Sadiq (pbuh) to open schools (madrasas) without any interference.

He taught many subjects including medicine, chemistry, geography, fiqh (laws of Islam), and explanation of the Qur'an.....

He had some very clever students like Jabir bin Hayyan who is known today as the 'Father of Chemistry'. Jabir always started his writings with "...I have learnt this from my master Ja'fer As-Sadiq (pbuh)....."

We are known as Ja'fery because we are the followers of the Fiqh (laws of Islam) as compiled by Imam Ja'fer As-Sadiq (pbuh).

When Imam was 65 years old, a bad ruler called Mansur sent him poisoned grapes.

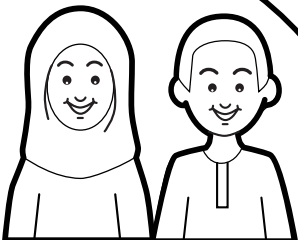

Imam died on the 25th of Shawwal 148 A.H. and is buried in Jannatul Baqee in Madina.

One of the companions of Imam - Abu Baseer went to the house of Imam to give his condolences to the family after Imam had died. Imam's wife - Sayyida Umme Hameeda was very sad. She told Abu Baseer that just before Imam had died he called his family members close to him and said:

“Those who take salaa lightly will not get our shafa'a (intercession)”

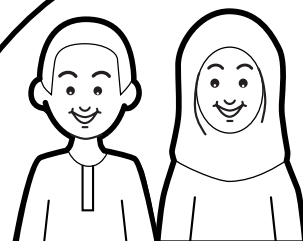

IMAM JA'FER AS-SADIQ (pbuh) THE TRUTHFUL ONE

يَا أَيُّهَا الَّذِينَ آمَنُوا اتَّقُوا اللَّهَ وَكُونُوا مَعَ الصَّادِقِينَ

“O you who believe have taqwa for Allah and be with the truthful ones.”

Suratut Tawba - 9:119

The Prophet (pbuh) has said:

“It is possible that a mu'min may be timid or a miser but it is not possible that he may be a liar.”

Imam Ja'fer As-Sadiq (pbuh) has said:

“Allah has never appointed anyone to the Prophetic mission except the one who has been truthful and honest.”

Just as the non believers of the Quraysh testified to the truthfulness of the Holy Prophet (pbuh) and called him As-Sadiq despite their hatred of his beliefs, so did the people of every group, creed and belief testify to the 6th Imams truthfulness.

Imam taught many subjects including Fiqh, Tafseer, Hadith, Medicine, Chemistry, Jafr (calculation in predicting future), Kalaam (roughly translated - theology).

His students include not only prominent people like Jabir bin Hayyan (known as Geber - Father of Chemistry) but also the 'Imams' of the Sunni schools of fiqh like Abu Hanifa (Noman ibn Sabit - Imam of the Hanafi's), Malik ibn Anas (Imam of the Maliki's), Ibrahim bin Saad Zahri (teacher of Ahmed bin Hambal - Imam of Hambali's), Saad bin

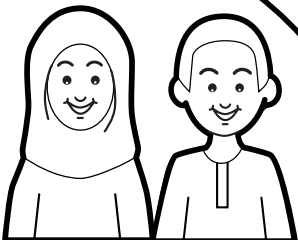

Muslim Awii (teacher of Shafi). His also saw a time when Muslims themselves were divided into groups.

When the khalifas saw that the people were going to Imam Ja'fer As-Sadiq (pbuh) for guidance, they appointed Imams (created political Imamate) in Kufa and Madina like Abu Hanifa & Malik bin Anas. People were paid to ask Abu Hanifa and Malik bin Anas questions (masail) but fined for going to the 6th Imam. Even then they still went to Imam Ja'fer As-Sadiq (pbuh)

Both Abu Hanifa and Malik bin Anas added and took away things in the religion according to their own thinking. Although they had learnt from the most truthful of teachers, their knowledge was limited and lacked divine guidance.

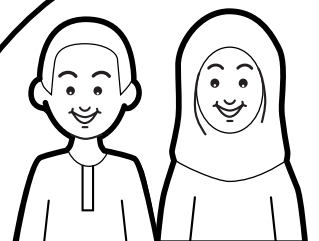

IMAM JA'FAR AS-SADIQ (pbuh) & RESPECT OF PARENTS!

In the time of our 6th Imam, Imam Ja'far as-Sadiq (pbuh) there lived a young man called Zakariya who had converted from Christianity to Islam.

On his way to Haj, Zakariya stopped in Madina to visit Imam Ja'far as-Sadiq (pbuh).

Zakariya asked the Imam how he should behave towards his family who were still Christians.

Imam replied that parents should be greatly respected in Islam, and told Zakariya to be kinder and more helpful to his mother than he had ever been.

When Zakariya returned home, he was much more respectful and helpful to his old mother than before.

He gave her food and drink with his own hands.

He washed her clothes and kept the house tidy. And he would hug and kiss her all the time.

His mother was very surprised but very happy with her son, and asked Zakariya what had made him become so kind towards her.

When Zakariya explained about our 6th Imam (pbuh) , his mother wanted to know more about Islam.

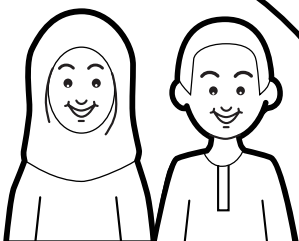

Zakariya told her all about the teachings of Islam and when he had finished; his mother became a Muslim too.

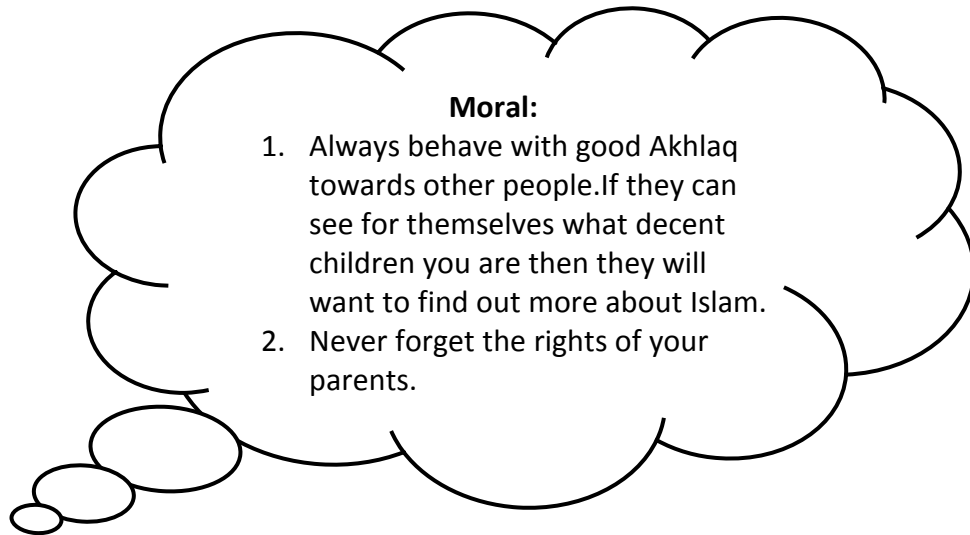

ANSWER THE FOLLOWING QUESTIONS:

1. Why does Islam tell you to act with good Akhlaq towards everyone?

2. Why do parents have so many rights in Islam?

3. Do parents have to earn these rights from their children

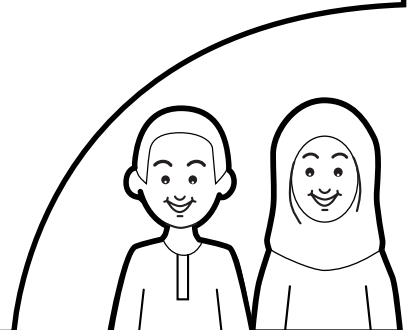

Activity:

Allah wants us to be kind to our parents.

In the boxes below draw pictures of how you can be kind to your parents:

E.g. By helping tidy your toys

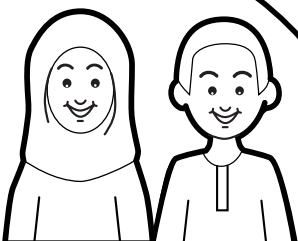
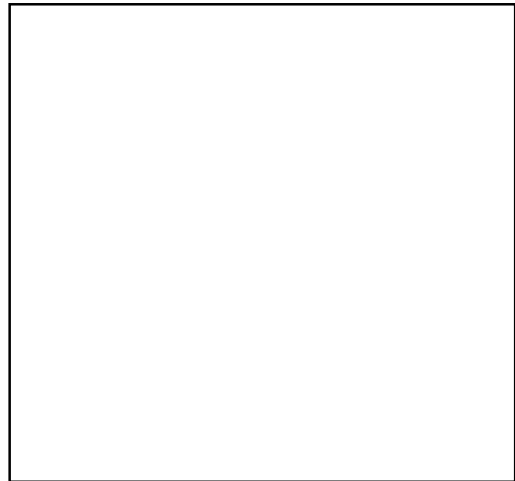

Imam Ja'fer As-Sadiq (pbuh)

Match the columns below:

Number of students
taught by Imam

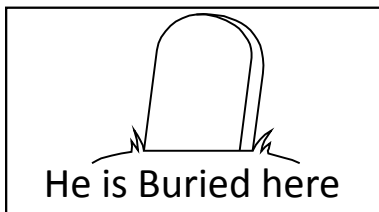

Imam Muhammed
Al- Baqir (pbuh)

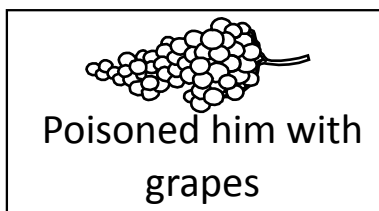
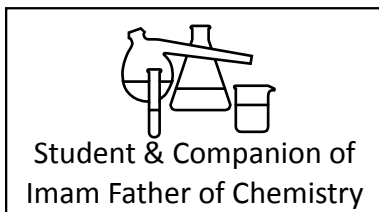

Umme Farwa

His Father

Jabir Ibn Hayyan

Mother

Mansur

4000

Jannatul Baqee

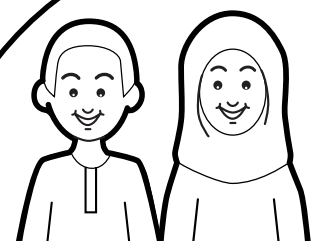

Imam Ja'fer As-Sadiq (pbuh)

Jabir Ibn Hayyan (known as Geber) who is the Father of Chemistry learnt from Imam Ja'fer As-Sadiq (pbuh)

Join the dots and colour the picture

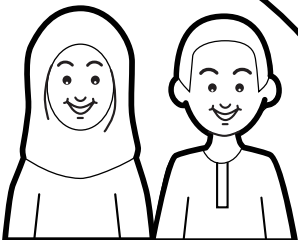
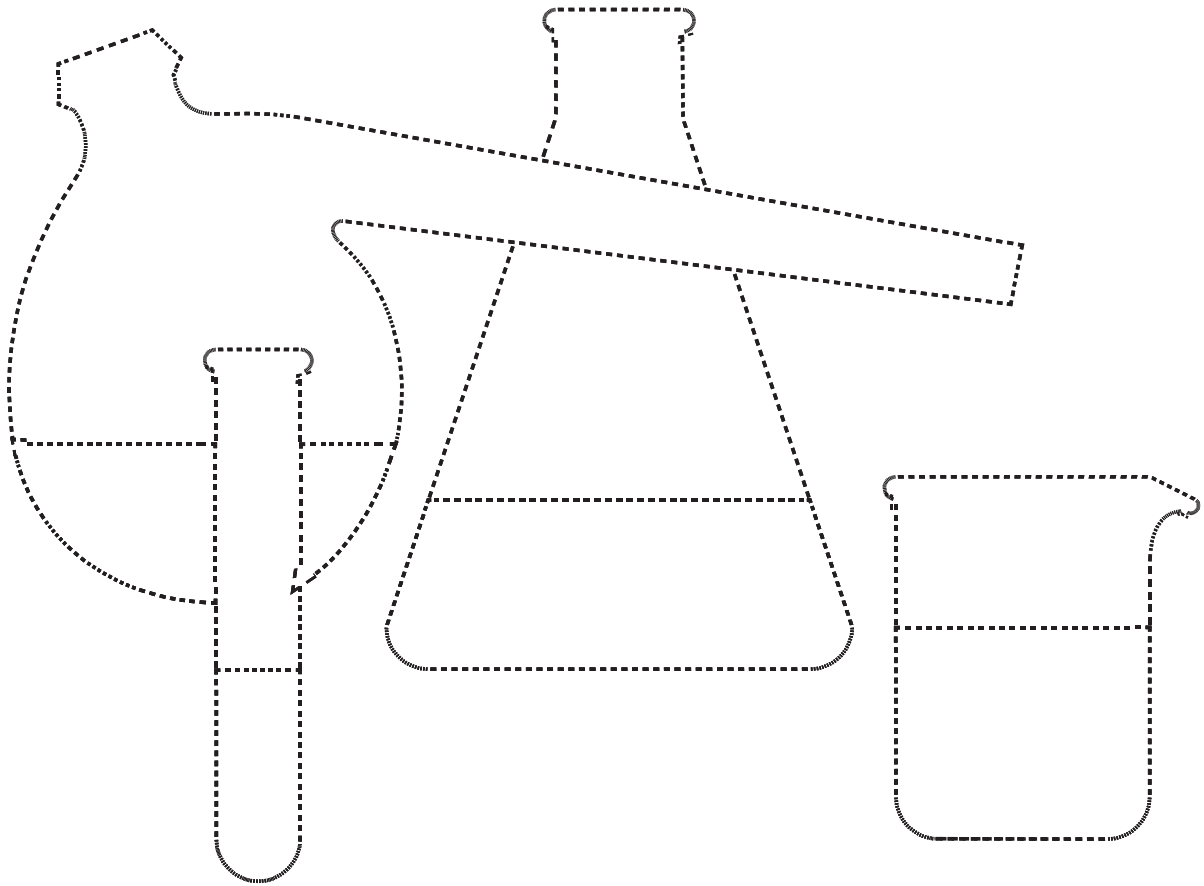

I Know my Imam...

My sixth Imam

Full Name:

Father's Name:

Mother's Name:

Date of Birth:

Place of Birth:

Children and Names:

.....

.....

Date of Death:

Burial Site:

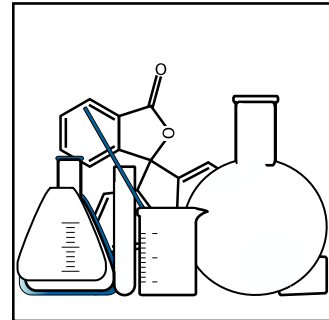

Teacher of
Chemistry

One Hadith / Saying:

Another Hadith / Saying:

The Ma'sum who:

.....
(write one specific aspect of his life by which you can remember him).

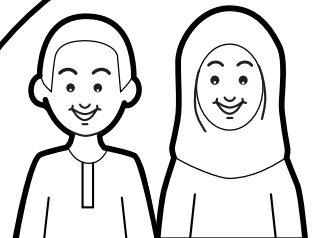

IMAM MUSA AL-KADHIM (pbuh) THE ONE WHO SWALLOWS HIS ANGER

He is the son of Imam Ja'fer As-Sadiq (pbuh) and Sayyida Hameeda.

He was born on the 7th of Safar 128 A.H. Because Safar is a sad month we celebrate his wiladat (birthday) on the 7th day of the 7th month (As he is our 7th Imam).

He was born in Abwa which is a place between Makka and Madina. Prophet Muhammad's (pbuh) mother - Sayyida Amina is buried there.

He was given the title Al-Kadhim which means 'someone who swallows his anger'. One who does not show his/her anger is patient. Like all the other AImma, he too could speak with wisdom from birth.

Once when Imam was 5 years old, a visitor of his father saw the young Imam with a lamb telling the lamb to bow down saying:
"Bow down to the One who made you."

A bad ruler called Harun Rashid put Imam in prison for 19 years. The prison was so small that Imam could not even stretch his legs. He was given only 2 pieces of dry bread and a glass of hot water per day. The same bad ruler killed the Imam by giving him poisoned dates. Imam died in Baghdad on 25th Rajab 183 A.H.

He is buried in Kadhmain - a part of Baghdad (Iraq).

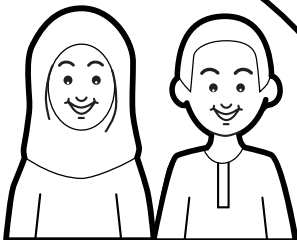

IMAM MUSA AL-KADHIM (pbuh) THE ONE WHO SWALLOWS HIS ANGER

فِي السَّرَّاءِ وَالضَّرَّاءِ وَكَاطِمِينَ الْغَيْظَ وَالْعَافِينَ عَنِ النَّاسِ ط
الَّذِينَ يُنْفِقُونَ
وَاللَّهُ يُحِبُّ الْمُحْسِنِينَ

“Those who spend (In the way of Allah) in prosperity and when poor, and who swallow their anger, and forgive (the faults of) people; And Allah loves those who do good.” **Suratu Aali Imran - 3:134**

In a situation in which the family and followers of the Ahlul Bayt were being murdered and tortured Imam Musa Al-Kadhim (pbuh) through his character and piety showed the meaning of tabligh living up to the hadith of the 6th Imam - "Acquire a true Islamic character and that shall spread Islam".

Harun Rashid had Imam arrested in the Prophet's mosque whilst Imam was praying. He was handcuffed and shackled and sent to Basra. Imam was put into prison under the custody of Isa bin Ja'fer. After a year Isa wrote to Harun saying he could no longer imprison Imam as he could find only piety and righteousness in him. Harun had

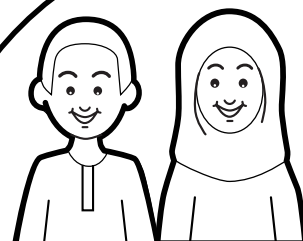

Imam moved to Baghdad under the custody of Fadhl bin Rabi who too became a follower of Imam.

The prisons were so small that there was no room to stand and the food was a cup of water and two pieces of dry bread a day. Imam remained patient. Harun also hired mercenaries to kill Imam. It is reported that they too on seeing Imam wept and refused to murder him even though they were paid to do so. Harun finally moved Imam into the care of Sindi bin Shahak (a very cruel man). Imam remained in prison for the last 19 years of his life. These years of imprisonment gave the Shia population a little relief as the rulers concentrated on Imam. It enabled the Shias to disperse from Arabia to Iran, India etc. thus spreading Islam and it was one of the factors towards the popularity of the 8th Imam.

In 183 A.H. Sindi had Imam killed with poisoned dates. Another narration says Imam was wrapped in a carpet and he was suffocated and stamped on. His body was left* on the bridge of Baghdad and an announcement was made for all to come and see him.

When Harun Rashid's brother Sulayman heard of this he was furious and arranged for his burial in a Quraysh cemetery outside Baghdad (the 8th Imam gave ghusl and kafan). A town grew around the tomb of Imam called Kadhmain (meaning the two Kadhims) since the 9th Imam is also buried there.



IMAM MUSA AL-KADHIM (pbuh) RESPONSE TO RUDENESS!

There was a poor uneducated farmer who was very rude to our 7th Imam, Imam Musa al-Kadhim (pbuh) whenever he saw him.

No matter how rude this man was, Imam (pbuh) never got angry and he never said anything to the man.

Imam's (pbuh) friends wanted to punish the rude man, but Imam (pbuh) would not allow them to. Imam (pbuh) told them that he himself would teach this man a lesson.

One day Imam Musa al-Kadhim (pbuh) rode out to the rude man's farm where the man was working. When the man saw Imam (pbuh) he stopped working and put his hands on his hips, ready to say bad things again.

Imam (pbuh) came down from his horse, went towards the man, and greeted him with a friendly, smiling face. Imam (pbuh) then told him that he should not overwork himself and that the land he had was very good. He then asked him how much he was expecting to receive for the crop.

The farmer was amazed at Imam (pbuh) politeness and sincerity, he waited a little then said that he was expecting to get around 200 gold pieces. Imam (pbuh) gave

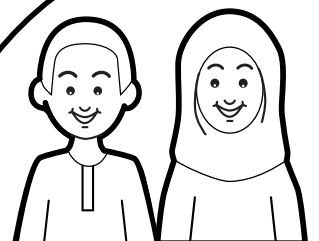

Him a bag and told him that in it was 300 gold pieces, more than the value of his crop. Imam (pbuh) told the man to take the money and also to keep the crop, and that he hoped the man would receive more for it.

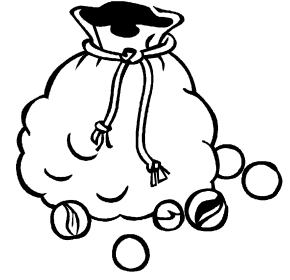

The farmer faced with such kind behaviour and good Akhlaq, was very ashamed of himself and asked Imam (pbuh) for forgiveness.

After that whenever the man would see Imam (pbuh) he would greet him very politely. The Imam's (pbuh) friends were very surprised!

Moral:

1. Do not treat people the way they treat you but always better.
2. Give to people even if they do not act as if they deserve it.

ANSWER THE FOLLOWING QUESTIONS:

1. What did Imam Musa al-Kadhim say to the man when he was rude to him?

2. How did Imam (pbuh) teach the rude farmer what he was doing was wrong?

3. Why did Imam (pbuh) give the man some money?



Al-Kadhim

The one who swallows anger

Draw a cross on the one who is angry.

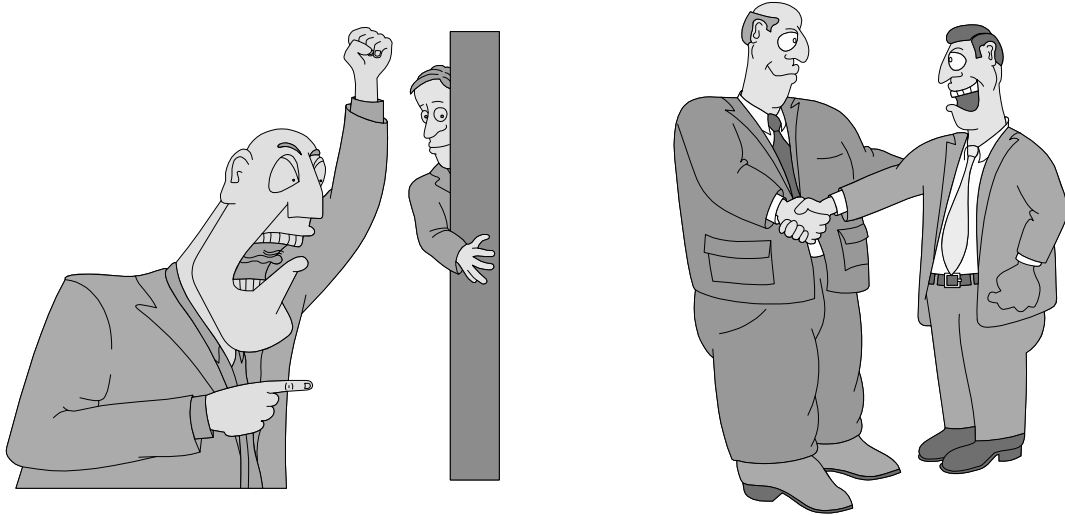

Draw a happy face and an angry face in the circles below.

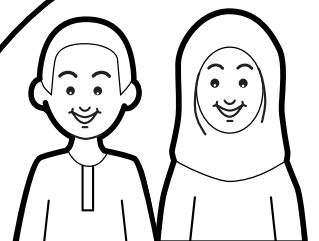
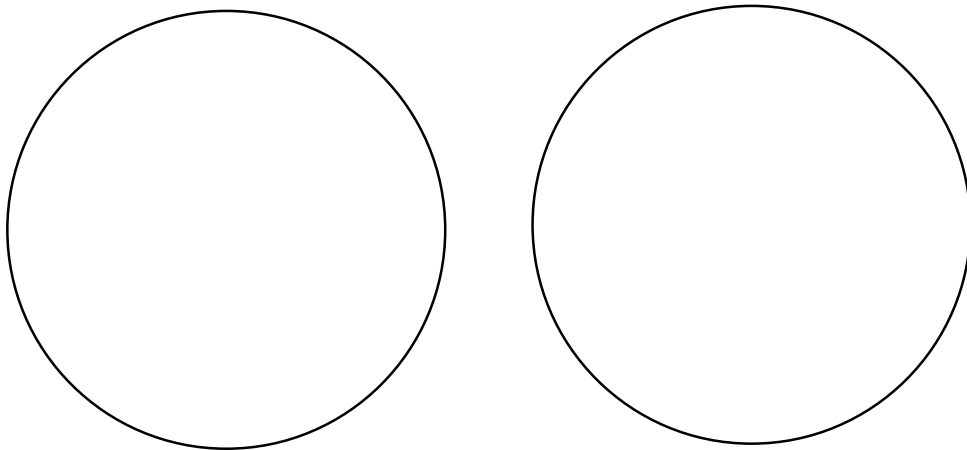

I Know my Imam...

My seventh Imam

Full Name:

Father's Name:

Mother's Name:

Date of Birth:

Place of Birth:

Children and Names:

.....

.....

Date of Death:

Burial Site:



Kadhmain is the
surburb of Baghdad

One Hadith / Saying:

Another Hadith / Saying:

The Ma'sum who:

(write one specific aspect of his life by which you can remember him).

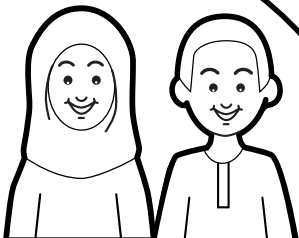

IMAM ALI AR-RIDHA (pbuh) THE ACCEPTED ONE

Imam Ali Ar-Ridha (pbuh) was born in Madina on the 11th Dhulqa'da 148 A.H.

His father is Imam Musa Al-Kadhim (pbuh) and his mother was Sayyida Ummulbanin Najma.

His grandfather Imam Ja'fer As-Sadiq (pbuh) used to tell his companions to await the birth of his grandson who would be very clever and known as 'Aalim aali Muhammad' - the learned one from the household of the Prophet (pbuh).

He was also known as Imam Zaamin (pbuh). Zaamin means safety. One day Imam was walking through the market place when he saw a hunter about to kill a deer. The deer was struggling. When the deer saw Imam she said something to him which he understood. Imam asked the hunter to free her so that she could feed her little ones who were hungry. The deer would then return to the hunter. The hunter thought Imam was making a fool of him, so Imam stood with the hunter until the deer came back with her young ones. She asked Imam to look after them.

The bad ruler Mamun had ordered that nobody was allowed to visit Karbala for Ziyara. Anybody who dared to go was killed.

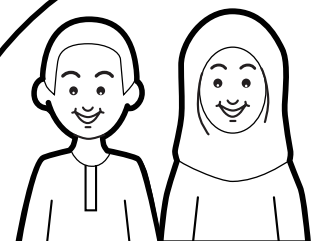

When Mamun forced Imam to become the heir apparent (to be ruler after him) just to become popular with the people, he said those who got a safety order from Imam Ali Ar-Ridha (pbuh) could go for Ziyara to Karbala. Imam encouraged the Ziyara and gave safety orders to who so ever wished to go.

When Mamun saw that Imam was becoming more popular than him he invited him one evening and gave him poisoned grapes.

Imam died on 29th Safar 203 A.H.

He is buried in Mash'had in Iran. He is also known as 'Gharibul Ghuraba' meaning one who is a stranger and far from family and home (Imam's home was in Madina).

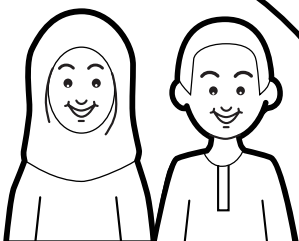

IMAM ALI AR-RIDHA (pbuh) THE ACCEPTED ONE

يَوْمَئِذٍ لَا تَنْفَعُ الشَّفَاعَةُ إِلَّا مَنْ أَذِنَ لَهُ الرَّحْمَنُ وَرَضِيَ لَهُ قَوْلًا

“On that day no intercession shall benefit them except of whom Allah permits and whose word He is pleased with.” **Suratu Taha - 20:109**

Intercession (Shafa'a) is reconciling justice with mercy. It means that we seek the Mercy of Allah by resorting to a connection who was more obedient toward Allah and, as a result, Allah answers his/her prayers faster than ours. Allah may forgive us because of the credit and the honour of that man/woman. This credit has been acquired by absolute obedience of Allah. As the above aya states, approving any intercession depends on Allah. Only those who display total obedience and are closest to Allah can intercede. What better intercessors can there be than the Ahlul bayt?

Shafa'a can only be for those who love and follow the Ahlul bayt and whose sins have been committed when not careful and are followed by genuine repentance.

In the hadith of the golden chain below, Imam re-iterates the following of the Ahlul bayt as a condition.

Imam Ali Ridha (pbuh) saw a short period of the rule of Harun Rashid who had murdered his father. Harun Rashid also attempted to kill Imam Ali Ridha (pbuh) but was unsuccessful. After Harun's death, his

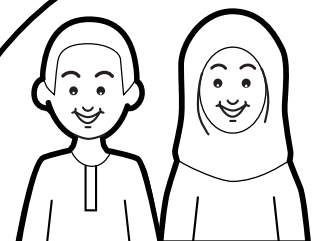

sons, Amin and Mamun fought for power. Mamun won with Amin being killed.

Immediately after becoming the Khalifa Mamun, according to the tradition started by Muawiya, had to name a successor (heir apparent). Mamun summoned Imam to come to his capital Marw sending a messenger to Madina to bring the Imam to him and specifying a certain route and sending a security force. On the way they entered a town called **Nishapur**. There the scholars and people requested Imam to tell them a hadith. Imam related the following hadith which is known as the hadith of the **golden chain**.

"My father Musa Al-Kadhim narrated to me from his father Ja'fer As-Sadiq from his father Mohammed Al-Baqir from his father Ali Zaynul Abedeen from his father , the martyr of Kerbala from his father Ali ibn Abu Talib saying : "My loved one, and the pleasure of my eyes, the Messenger of God (pbuh) told me once, that Jibrail told him from the Lord "The kalima of **La ilaha illallah** is my fort; whoever says it would enter my fort; and whoever enters my fort is safe from my punishment".

Those who wrote down the hadith numbered twenty thousand.

People started reciting the Kalima when Imam put his hand up and continued:

"Yes, the kalima is Allah's fort. It will provide you with excellent safety but on one condition only and that is that you obey and follow us - the holy Imams in the progeny of the holy Prophet (pbuh).

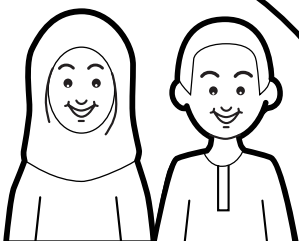

Hadith of the golden chain

Write the names of the Prophet (pbuh) and Aemma upto Imam Ridha (pbuh) preferably with gold glitter on strips of paper.

Make a paper chain and connect it to some wings with Jibraeel written on them and then to a circle with Allah on it.

Connect the bottom of the chain to a FORT with Laa Ilaha Illallah written on it.

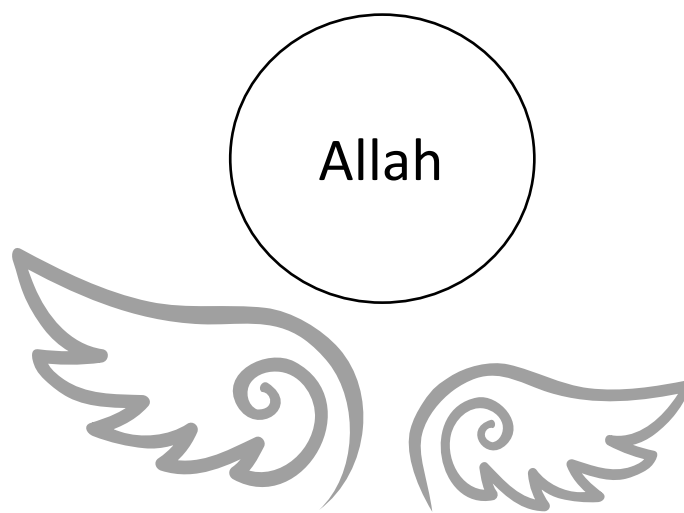

Allah

Jibraail

Name of Ma'sum

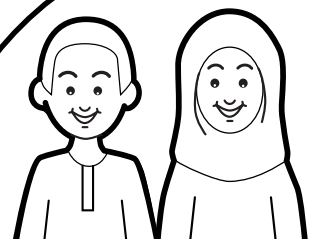

I Know my Imam...

My eighth Imam

Full Name:

Father's Name:

Mother's Name:

Date of Birth:

Place of Birth:

Children and Names:

.....

.....

Date of Death:

Burial Site:



The deer is saved
by Imam Zaamin

One Hadith / Saying:

Another Hadith / Saying:

The Ma'sum who:

.....
(write one specific aspect of his life by which you can remember him).

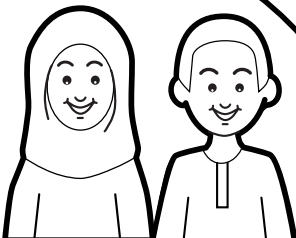

IMAM MUHAMMAD AT-TAQI (pbuh) THE PIOUS ONE

He is the only son of Imam Ali -Ar-Ridha (pbuh)

His mother was Sayyida Sabika Khaizarun.

He was born on the 10th of Rajab 195 A.H. in Madina.

One day when he was 5 years old, he was with some other children. The bad ruler Ma'mun who had poisoned his father passed by in his carriage. All the other children ran away but Imam stayed.

Mamun stopped his carriage and asked the young Imam why he was standing there. Imam told him that the road was wide enough for all of them and he had not done anything wrong. Ma'mun asked him who he was. When Imam told him that he was the son of Ali Ar-Ridha (pbuh) Ma'mun asked him if he knew what was in Ma'mun's hand (Ma'mun was hiding a tiny fish in his hand).

Imam said:

“Allah has made tiny fish in the rivers. These fish are hunted by the rulers and it is the Aimmah who reveal the secrets of the rulers.”

Imam Muhammad At-Taqi (pbuh) prepared the Muslims for the time when the 12th Imam would come. He did this by training the Muslims to ask questions and take advice from those who had learnt the Qur'an, the laws of Islam and who were muttaqee (those with taqwa - who did all the wajib things and did not do haram things). This is called taqleed.

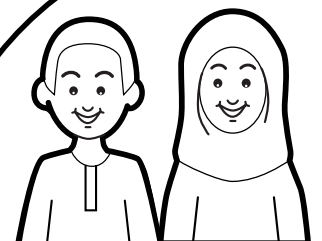

After Ma'mun died the bad ruler Mu'tasam arranged for Imam to be poisoned.

Imam was only 25 years old when he was poisoned and he is buried near his grandfather in Kadhmain (Iraq). His wafat (death day) is on the 29th of Dhulqa'da 220 A.H.



IMAM MUHAMMAD AT-TAQI (pbuh) THE PIOUS ONE

تِلْكَ الْجَنَّةُ الَّتِي نُورِثُ مِنْ عِبَادِنَا مَنْ كَانَ تَقِيًّا

“This is the Janna which will be inherited by those who serve Us who have taqwa.”
Suratu Maryam - 19:63

The 8th Imam was 45 years old when the 9th Imam was born. Imam Muhammad At-Taqi (pbuh) became an Imam at the age of 9.

Mamun Rashid who was the khalifa at the time thought that all the rulers before him had fought with (oppressed) the Imams and their schemes had backfired. So he would try to buy (bribe) the Imams. He tried to make the 8th Imam his heir apparent and give him power and wealth but that too backfired.

He now tried to use power and wealth with the 9th Imam again but from a much younger age thinking that he would be able to influence him.

His main purpose was also to make sure that the 12th Imam (whom he knew would bring justice to the world) would be from his progeny and therefore intended to give his daughter Ummul Fadhl to the Imam for a wife. This infuriated his family (Banu Abbas). To prove to them the excellence of Imam even at a young age he arranged a meeting between Imam and the most learned of men at that time - Yahya bin Athkam.

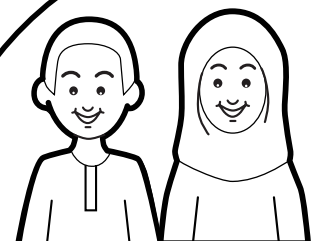

It was a big occasion with 900 other scholars present too. Imam was first asked by Yahya: What is the compensation (kaffara) for a person in Ehraam who hunted and killed his prey?"

Imam replied that there were many more details required before he could answer that question as the question was incomplete:

1. Did the Muhrim (one in Ehraam) hunt in the haram or outside?
2. Did the Muhrim know sharia or not?
3. Did he hunt intentionally or not?
4. Did he hunt for the first time or was this one of many times?
5. Was he free or a slave?
6. Was his prey a bird or an animal?
7. Was it big or small?
8. Had he hunted by day or by night?
9. Was he baligh or not?
10. Was he repentant or not?
11. Was his ehraam for Hajj or Umra?

Yahya was stunned. He looked down and started sweating.

Mamun asked the young Imam to answer the question himself which he did and then Imam asked Yayha a question which he could not answer.

The Banu Abbas admitted defeat and Mamun took the opportunity to offer his daughter in marriage to Imam. Imam read his own Nika (the khutba of which is used today) with the Mehr of 500 dirhams. Imam wrote a letter to Mamun that he would also give Ummul Fadhl Mehr from the wealth of Aakhira. This was in the form of 10 duas which

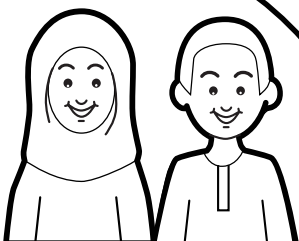

were for fulfilling any hajaat (desires) [Chain of narrators upto Prophet - Jibrail - Allah]* .

* These duas are found in Mafatihul Jinaan (pg 447 - In margin)

Imam lived for a year in Baghdad with Ummul Fadhl. She was very disobedient to Imam. When she found out that Imam had another wife (from the progeny of Ammar-e-Yasir) and that there were also children including Imam Ali An-Naqi (pbuh) she was jealous and angry realising that her father's plan had failed.

Mamun tried a new tactic. He tried to deviate Imam by sending him beautiful girls and musicians. When he realised nothing was working he let Imam return to Madina.

Imam used this time to prepare the masails of Taqleed and Ijtihad in preparation for the 12th Imam knowing that both the 10th and the 11th Imam would spend most of their lives in prison. He also prepared the people of Madina knowing that this would be the last time they would be able to receive guidance directly from an Imam for a long time.

Ummul Fadhl continuously complained of Imam to her father who sent her letters back. Mamun died in 218 A.H. and was succeeded by his brother Mo'tasam Billah. He openly announced that all Shias were not Muslims. He said it was wajib for people to kill & prosecute Shias, & destroy property belonging to Shias. They would not be prosecuted.

Ummul Fadhl now started complaining to her uncle who was sympathetic to her. Mo'tasam called Imam to Baghdad. He asked

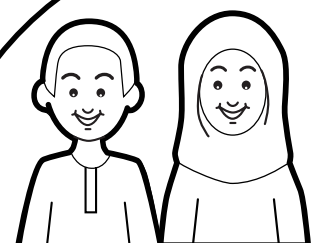

Imam to pass judgement on how to punish a thief. Imam said only fingers could be cut as the palms were for Allah (as in Qur'an - it is one of the wajib parts to touch the ground during sajda). As this decision was contrary to the decision of the other 'Ulema' it strengthened the position of the Shias. The other 'Ulema' complained to Mo'tasam. With instigation from both the 'Ulema' and Ummul Fadhl, Mo'tasam sent poison which Ummul Fadhl put in Imam's drink and gave it to him. Imam died on 29th Dhulqa'ada at the age of 25 years and is buried near his grandfather in Kadhmain (the 10th Imam gave him ghusl and kafan).

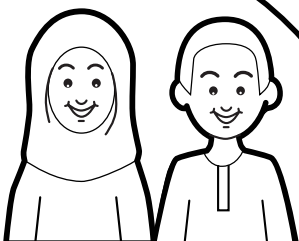

IMAM MUHAMMAD AT-TAQI (pbuh) EARNs RESPECT AT YOUNG AGE.

Our 9th Imam, Imam Muhammad at-Taqi (pbuh) had an uncle called Ali ibne Jaffar, who was a very knowledgeable, pious old man. Whenever he went to the mosque, people would surround him and ask him questions.

One day Imam Muhammad at-Taqi (pbuh) arrived at the mosque. When his uncle who was sitting in the middle of a large group of people saw him, he immediately got up and kissed the hand of Imam (pbuh).

Imam Muhammad at-Taqi (pbuh) asked his uncle to sit down, to which his uncle replied that he could not sit while Imam (pbuh) was standing. When Ali ibne Jaffar returned among his friends, after Imam (pbuh) had left, his friends told him that it was wrong for him to show so much respect to that child Imam (pbuh) as he was an old man and the uncle of the child.

Ali ibne Jaffar replied that he was showing respect to the child because of who he was. He continued that Imamate is an office and a station from Allah, and Allah

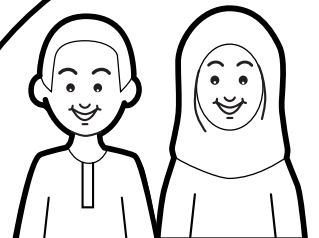

did not consider him, an old man, fit and capable for the leadership of the Ummah, but considered the child capable for it. Therefore they should all obey his (Imam (pbuh) commands.

Moral:

1. The age of a person is not important but what kind of person they are.
2. Only Allah knows everything about everyone and therefore only Allah is allowed to judge people, and say what

ANSWER THE FOLLOWING QUESTIONS:

1. What did the uncle of Imam Muhammad at-Taqi (pbuh) do when Imam (pbuh) entered the mosque?

2. What did the people tell the uncle when he did this?

3. What was the uncle's reply to these people?



Activity:

Colour the pictures and write down underneath each one how you'd treat that person!

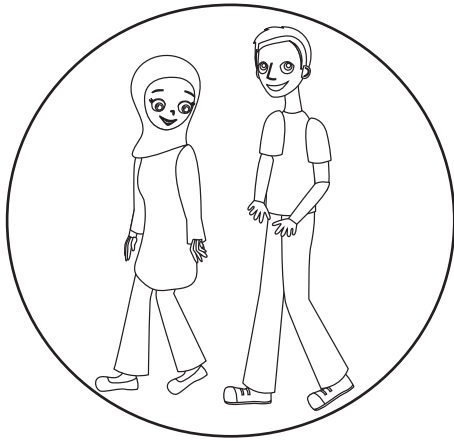

With.....



With.....

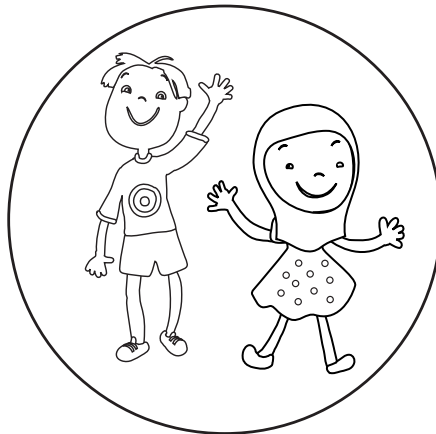

With.....

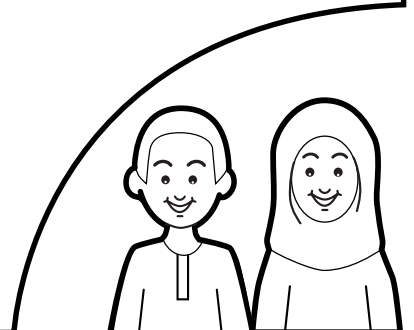

I Know my Imam...

My ninth Imam

Full Name:

Father's Name:

Mother's Name:

Date of Birth:

Place of Birth:

Children and Names:

.....

.....

Date of Death:

Burial Site:

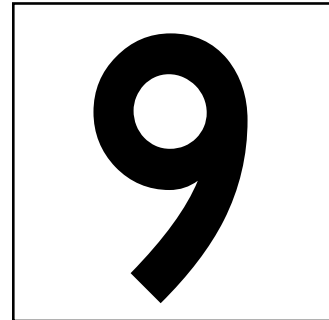

Became Imam
at the age of 9

One Hadith / Saying:

Another Hadith / Saying:

The Ma'sum who:

(write one specific aspect of his life by which you can remember him).



IMAM ALI AN-NAQI AL-HAADI(pbuh) - THE PURE ONE, THE GUIDE

He was born in Surba (a district of Madina) on 15th Dhulhijja 212 A.H. His father is Imam Muhammad At-Taqi (pbuh) and his mother was Sayyida Sumaanaa.

The ruler of the time was a bad man called Mutawakkil. Like Saddam Tikriti he too tried to destroy the shrine of Imam Husayn (pbuh) and was very cruel. He even tried to flood the grave of Imam Husayn (pbuh) so nobody would know where it was. He did not like anyone to visit Karbala. Imam Ali An-Naqi (pbuh) encouraged people to visit Karbala even though it was very difficult. He told them to do majaalis of Imam Husayn (pbuh) as much as possible.

He, like his father also prepared the rules of taqleed - to follow someone who knows the Qur'an, laws of Islam, and has taqwa. This was to prepare Muslims for the ghayba of Imam Muhammad Al-Mahdi (pbuh)

Imam Ali An-Naqi (pbuh) opened schools (madrasas) in Madina where many students came to study. The bad ruler Mutawakkil did not like this and summoned Imam to Samarra where he would not let Imam leave his house or let anyone visit him (kept him under house arrest).

Another bad ruler called Mu'taz poisoned Imam and he died on the 3rd of Rajab 254 A.H.

He is buried in Samarra (Iraq).

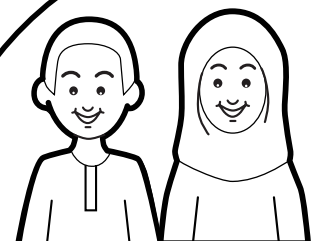

IMAM ALI AN-NAQI AL-HAADI(pbuh) - THE PURE ONE, THE GUIDE

وَالَّذِينَ جَاهَدُوا فِينَا لَنَهْدِيَنَّهُمْ سُبُلَنَا

“And those who do jihaad (strive) in our cause; surely We shall guide them in Our ways...”
Suratul Ankabut - 29:69

He became an Imam at the age of 8 years. The khalifa wrote to the governor of Madina asking him to send the young Imam to a person called Junaydi for tutorage (the governor of Madina was threatened that if he did not do this than the people of Madina would be annihilated). Junaydi was a well known poet of that time and 'anti - Ahlulbayt' and was 80 years old. The Khalifa felt that if this was done then anything that the Imam did or said could be attributed to Junaydi i.e. It was taught to Imam by Junaydi. When Junaydi was once asked about the progress of his student he said:

"I am the student and he is the teacher. I now know what knowledge is. What I say is because of what I have been taught by Imam". The Khalifa's plan had failed yet again.

For a while the Khalifa left Imam in peace and freedom as they were engrossed in sorting out their own affairs (Removing the Iranians from power; adding the Turks and establishing power in Samarra). Imam used the time to open Madrasas and the atmosphere in the mosque of the Prophet was once again like in the time of the 6th Imam Ja'fer As-Sadiq (pbuh)

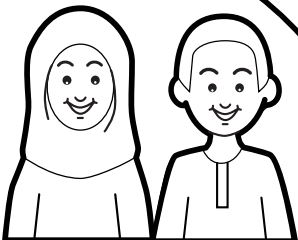

He served the longest period of Imama (besides the 12th Imam) - 34 years which can be divided into two parts - 17 years of freedom and 17 years under arrest.

In 234 A.H. came one of the most tyrannical rulers of the Abbasid Khilafate - Mutawakkil. He ruled with tyranny, killing, looting and terrorising especially those who were the followers of Ahlulbayt. Mutawakkil is also the one who ordered the desecration of the grave of Imam Husayn (pbuh) wanting to remove Imam's body and burn it (He did not succeed). He tried running water over the grave so no trace of the grave would remain but was unsuccessful. He ordered that all those wanting to visit Karbala would have their fingers cut off, then hand and feet cut then only be able to go if one other from the family was killed. Imam still asked Shias to visit Karbala. When Mutawakkil saw that all had failed and it did not discourage the visits then he banned all visits to Karbala completely.

Mutawakkil called Imam to Samarra. Imam was called under the pretext of respect and love towards him. Imam was aware of Mutawakkil's intentions but went knowing that this would be an opportunity to show the Turks too what true Islam was. On arriving in Samarra the Turkish spies sent with Imam were amazed at Imam's knowledge of the Turkish language when he had never visited the Turks before.

It was an opportunity for Imam to prepare the Mu'mineen in Samarra for ghaibat. Imam was put up in an Inn which was meant for beggars, destitute and criminals. From this Inn he was removed and put into the custody of an evil man called Zarraqui (who changed to be an avid supporter of Imam) and then a man called Seyyid.

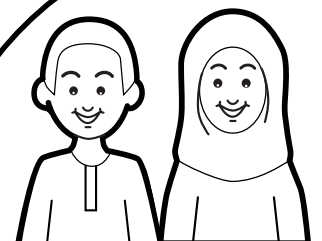

Mutawakkil knew of the progress Imam had made in Madina in 14 years of spreading knowledge.

Mutawakkil seeing that he could not humiliate Imam in any way, announced his arrival in Samarra as Ibnur Ridha (son of 8th Imam) and subjected him to things such as handing him a glass of wine in his hands in his court, asking him to sing, making him run in front of his (Mutawakkil's) carriage..etc.

Imam Hasan Al-Askery (pbuh) was placed under separate house arrest from his father at the young age of 5 years as Mutawakkil did not want the birth of the 12th Imam.

Whilst under house arrest Imam Ali An-Naqi (pbuh) arranged for the coming of Sayyida Narjis to Samarra and for her to be well versed in Fiqh by his learned sister Sayyida Hakima.

Imam spent his life making the imminent ghaiba of the 12th Imam easier preparing his learned companions to be his representatives and setting up a network of organisations for the collection and distribution of khums.

Soon after Mutawakkil was killed by his own son who could not withstand the behaviour of his father.

After Mutawakkil's death his son Muntasir was the successor and he lifted the restrictions of visiting Kerbala. His rule was unlike his father's tyranny but remained in power for only 6 months and died at the age of 25 years.

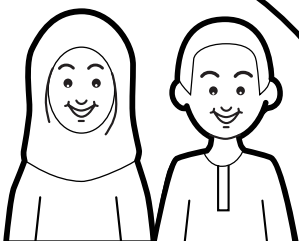

Then came Mustan Billah (Ahmed bin Mo'tasam) followed by Mo'taz Billah who continued his tyranny on Imam and his followers.

Mo'taz arranged for the poisoning of Imam through an ambassador and Imam was martyred on Monday 3rd Rajab 254 A.H.

Nobody except Imam Hasan Askery (pbuh) was present at the time of his death. He gave his father ghusl and kafan and wept bitterly.

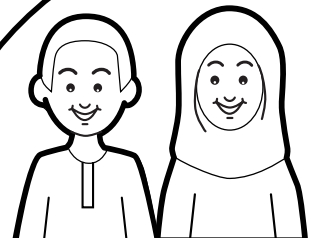

IMAM ALI AN-NAQI (pbuh) ENTERS THE CAGE OF LIONS!

Once in the time of our 10th Imam, Imam Ali an-Naqi (pbuh), a lady came to the Khalifa, Mutawakkil and said that she was Zainab (pbuh), the daughter of Fatimah (pbuh), the daughter of the Prophet (pbuh).

Mutawakkil told her that this could not be true because many years had passed since the time when Zainab (pbuh) was alive, and the lady looked very young.

The lady answered that she was Zainab (pbuh) and that she looked young because the Prophet (pbuh) had passed his hand over her head and prayed for her to remain young for ever.

Mutawakkil did not know what to do so he called all the wise men and asked them. All of them said that the lady was lying, but how were they to prove this.

No-one could think of any way to prove that the lady was lying, so then Imam Ali an-Naqi (pbuh) was called.

Imam Ali an-Naqi (pbuh) told Mutawakkil to put the lady into a cage of lions and if what she said was true, then the lions would not harm her, because the wild animals do not hurt the children of Fatimah (pbuh).

The lady said that Imam Ali an-Naqi (pbuh) wanted to kill her and that if what he said was true then let him go into the cage first.

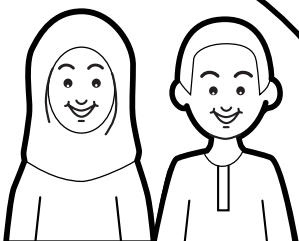

Imam Ali an-Naqi (pbuh) agreed and went into a cage of lions. The lions did not harm Imam (pbuh) instead they caressed him. Imam Ali an-Naqi (pbuh) then came out and told the lady that now it was her turn.

The lady began to cry and said that she was sorry and that she did not mean to lie, it was only a joke.

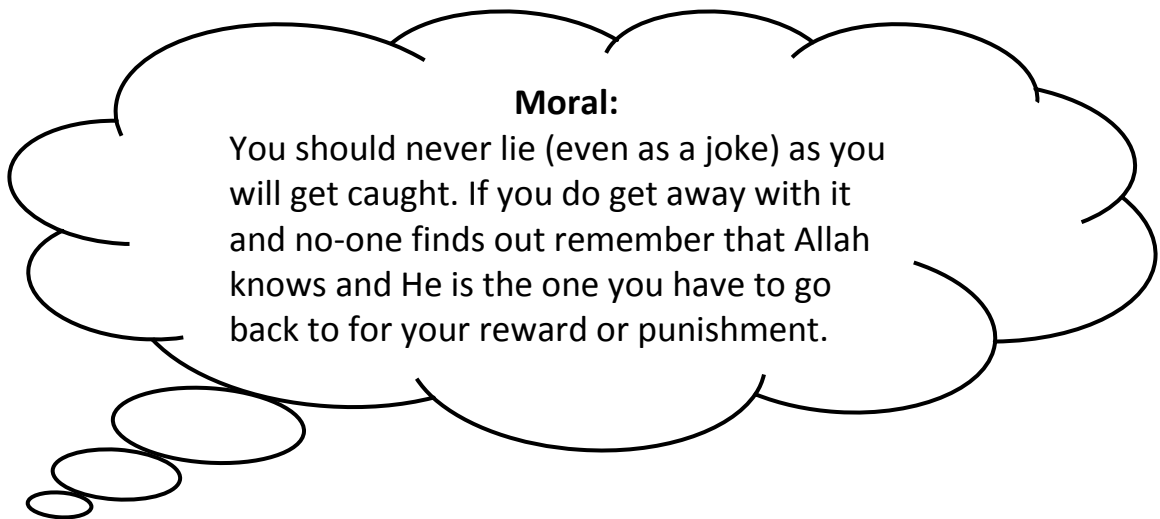

ANSWER THE FOLLOWING QUESTIONS:

1. What did Imam Ali an-Naqi (pbuh) tell the lady to do to prove that she was Zainab?

2. What was the lady's reply and why?

3. What happened when Imam (pbuh) went into the cage of lions?

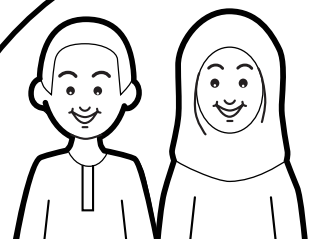

Activity:

Trace the following pictures onto a piece of paper. On the new paper, colour, then cut them out and glue sticks to the back to make puppets. Then act out a story with your family.

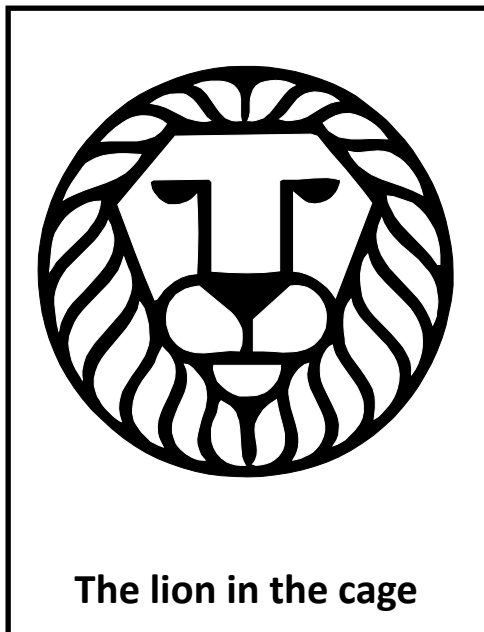
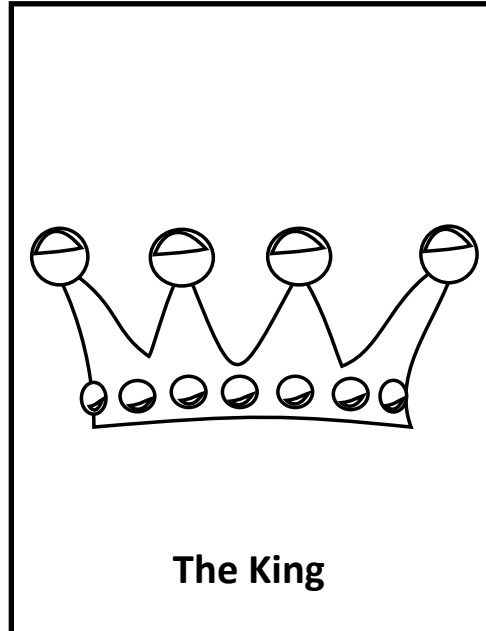
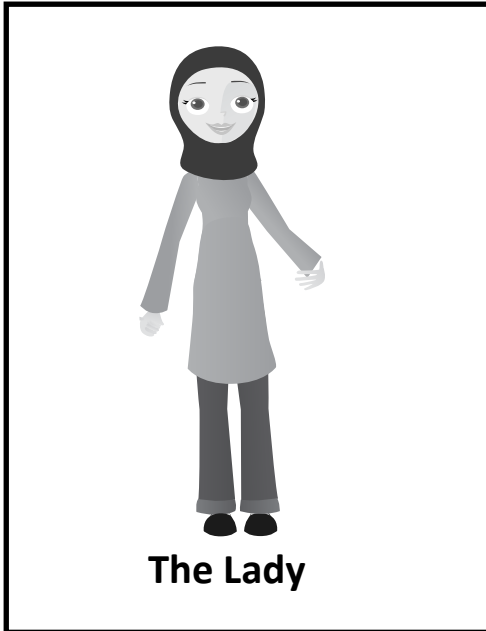

Taqleed

Match the columns

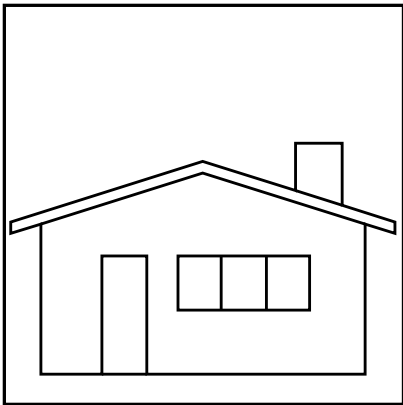
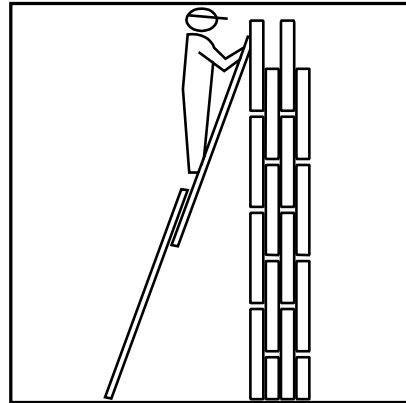
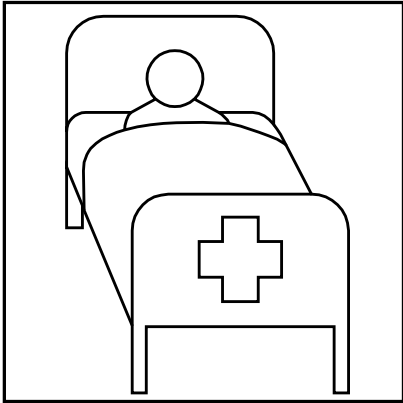

Marja' Taqleed
most
learned scholars

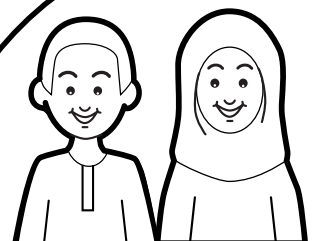
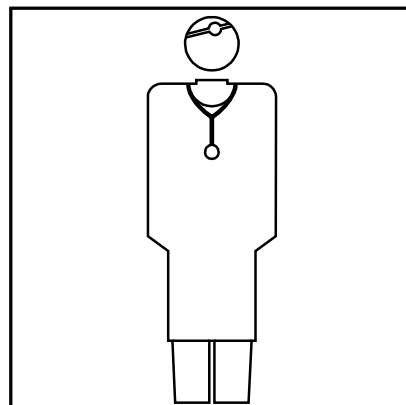
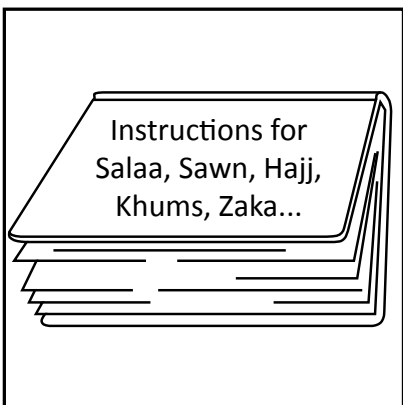

I Know my Imam...

My tenth Imam

Full Name:

Father's Name:

Mother's Name:

Date of Birth:

Place of Birth:

Children and Names:

.....

.....

Date of Death:

Burial Site:

Al-Haadi
The Guide

One Hadith / Saying:

Another Hadith / Saying:

The Ma'sum who:

.....
(write one specific aspect of his life by which you can remember him).

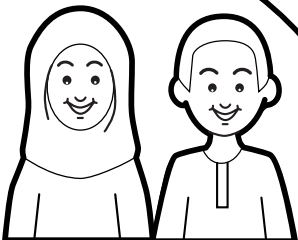

IMAM HASAN AL-ASKERY (pbuh)

Imam Hasan Al-Askery (pbuh) was born in Madina on the 10th of Rabi ul Aakher 232 A.H.

His father is Imam Ali An-Naqi (pbuh) who is our 10th Imam and his mother was Sayyida Sulail.

Once when he was a little boy he fell into a well near his house. His father was praying salaa and his mum started crying. When Imam Ali An-Naqi (pbuh) finished praying he was told what had happened. Smiling he went to the well. The water rose up to the top and the young Imam Hasan Al-Askery was sitting on it.

Imam Hasan Al-Askery (pbuh) was put into prison from a young age. The prison was a tunnel under the bad ruler's bedroom with no space to stand or lie down. His daily meal was a piece of dry bread and a glass of hot water.

Like his father and grandfather, he prepared the Muslims for the ghayba of Imam Muhammad Al-Mahdi (pbuh) He compiled all the laws of fiqh completing his fathers' work. He also set up a system whereby people could contact his representatives. This system today in the ghayba of Imam helps us to turn to the mujtahideen when we are in need of guidance.

He was poisoned by the bad ruler Mu'tamad. The poison made him very ill and he was in pain for 8 days.

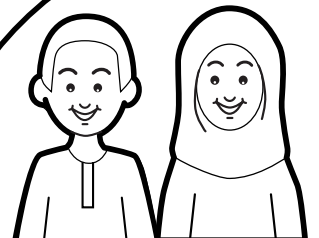

He died on the 8th of Rabi ul Awwal 260 A.H. and is buried in Samarra.

His salaa alal mayyit was led by Imam Muhammad Al-Mahdi (pbuh)



IMAM HASAN AL-ASKERY (pbuh)

لرَّسُولَ فَأُولَئِكَ مَعَ الَّذِينَ أَنْعَمَ اللَّهُ عَلَيْهِمْ مِنَ النَّبِيِّينَ وَالصِّدِّيقِينَ
وَ مَنْ يُطِيعِ اللَّهَ وَ
وَالشُّهَدَاءِ وَ الصَّالِحِينَ وَ حَسُنَ أُولَئِكَ رَفِيقًا

“And who ever obeys Allah and the Prophet, these shall be those on whom Allah has bestowed ne’ma upon of the Prophets, and the Truthful ones, and the Martyrs, and the Righteous ones - and they are **excellent** companions.”

Suratun Nisa

- 4:69

Ahmed Bin Ishaq relates that when he heard of the death of the 10th Imam he went to Samarra and asked for the whereabouts of the 11th Imam. He was told that Imam had been imprisoned by Mo'taz Billah. After bribing the guards he was able to visit Imam one night. He described the prison as a tunnel under the Khalifa's home where there was no space to stretch ones legs nor room to be able to stand. Ahmed says he cried when he saw Imam's condition. Food was only one glass of water and a piece of dry bread a day.

He was imprisoned because all the rulers knew of the justice that was promised to come with the coming of the 12th Imam and they wished to prevent anyone being born of the 11th Imam.

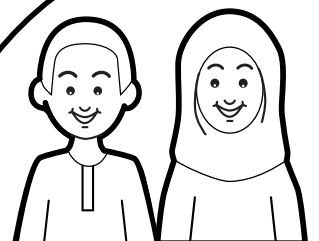

Whilst in prison he told his companions to accumulate all the masails of Fiqh and he completed the masails on the chapters that were found missing. He introduced the institution of "Taqleed" advising people to follow those who were learned, "Muttaqi" and just, as he was in prison and it was extremely difficult for people to meet him. Khums was collected through his representative and masails too asked to him, Abu-Ja'fer Uthman bin Saeed, who was later to become the representative of the 12th Imam.

There was once a severe drought in Samarra and a Christian priest came who whenever he raised his hands caused rain to fall from the heavens. The Muslims faith started wavering and the Khalifa Mo'taz Billah got worried for if they left Islam he would have none to rule over.

He went to the 11th Imam saying that Imam's grandfathers religion was in trouble. Imam asked him to call all the people outside Samarra with the Christian priest. He asked the Christian priest to pray for rain. When he raised his hands to pray it started to rain. Imam asked for whatever was in this hands to be taken away and then asked him to pray for rain again. There was no rain this time. Imam showed that what the priest had in this hand was the bone of a Prophet which whenever placed under the open sky caused it to rain. Imam then prayed for rain and it rained. Mo'taz could not re imprison Imam for some time for when the people saw the miracle they all wanted to visit Imam and asked where they might find him. Imam pointed to the Khalifa and asked them to ask him. Mo'taz told them that Imam was staying at the house where the 10th Imam used to reside.

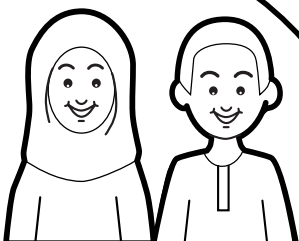

Sayyida Narjis was there and it was in that year that the 12th Imam was born.

Imam was allowed out of prison for 13 months after which he was re-arrested. In the six years of his Imamate several attempts were made on his life.

On the 1st of Rabi-ul Awwal 260 A.H. Mo'tamad arranged for Imam to be poisoned in prison and then sent him home. Imam was in great pain and difficulty for 8 days. On the 8th of Rabi-ul Awwal he asked his son, the 12th Imam, to bring him some water and then leave him. He died that day and was given ghusl & kafan by the 12th Imam.

The funeral prayers were led by the 12th Imam and it was then that a lot of Shia's saw him for the first time. A large number of people attended the funeral and he is buried in Samarra.

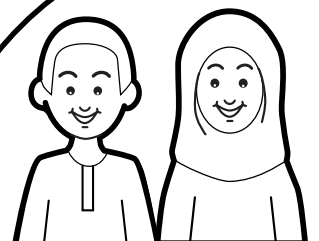

The signs of a Mu'min

Imam Hasan Askery (pbuh)

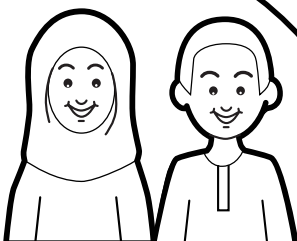
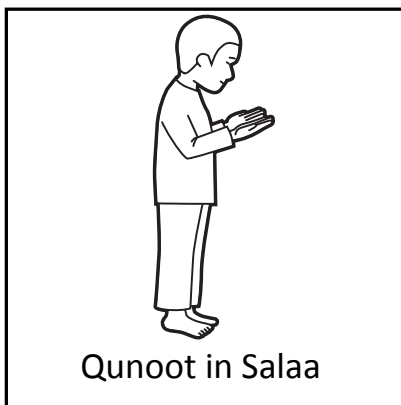
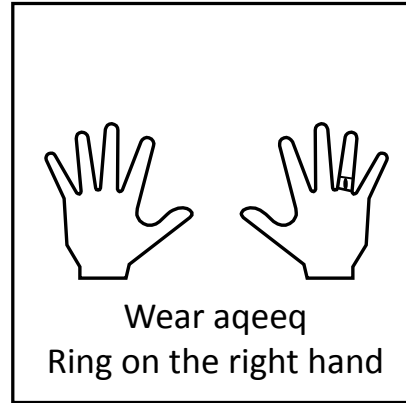
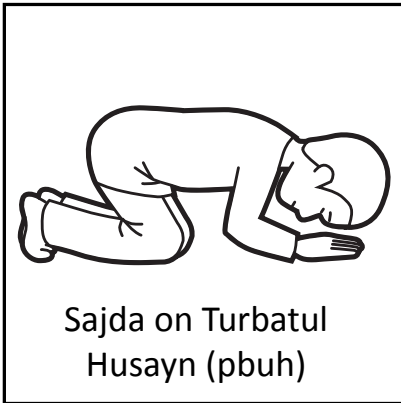

I Know my Imam...

My eleventh Imam

Full Name:

Father's Name:

Mother's Name:

Date of Birth:

Place of Birth:

Children and Names:

.....

.....

Date of Death:

Burial Site:



Was imprisoned most of his life

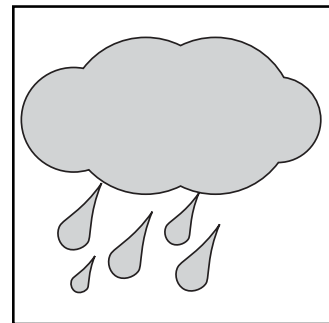

Prayed for rain

One Hadith / Saying:

Another Hadith / Saying:

The Ma'sum who:

.....
(write one specific aspect of his life by which you can remember him).

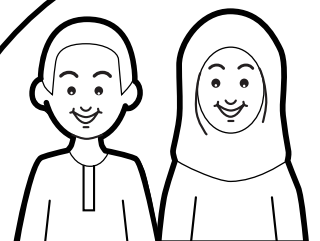

IMAM MUHAMMAD AL-MAHDI (pbuh) - THE GUIDED ONE

He was born on the 15th of Sha'ban 255 A.H. in Samarra.

His father is Imam Hasan Al-Askery (pbuh) and his mother was Sayyida Nargis.

Imam is still alive and in this year (1431 A.H.) he is 1,176 years old).

He is OUR Imam. Every week he gets a report of what we do from the angels recording our deeds with Allah's permission. He feels very sad when he sees if we have done something that is naughty or bad.

Imam Muhammad Al-Mahdi (pbuh) is in ghayba. This means that although he is amongst us we do not recognise him when we see him.

Whenever we need help we must ask Allah through Imam Muhammad Al-Mahdi (pbuh)

Whenever we hear his name we should bow down, put our hand on our head and recite salawaat.

When Allah orders, Imam will make himself known to us. We must pray to Allah to make this happen quickly and to keep Imam safe.

When he makes himself known to the world, he will want us to be his soldiers so that the world can be a better place. A world of justice. We should prepare to be his soldiers by being the best of Muslims -



by having taqwa (keeping away from all haram acts and doing all the wajib acts).

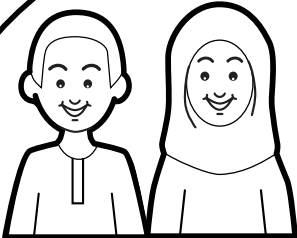

IMAM MUHAMMAD AL-MAHDI (pbuh) - THE GUIDED ONE

وَ قُلْ جَاءَ الْحَقُّ وَ زَهَقَ الْبَاطِلُ ط إِنَّ الْبَاطِلَ كَانَ زَهُوقًا

“And Say: The truth has come and falsehood has vanished, Indeed falsehood is a vanishing (thing).” **Suratu Bani Israil - 17:81**

“One who dies without knowing his/her Imam of the period, dies the death of ignorance.” **Prophet Muhammad (pbuh)**

الَّذِينَ اسْتَضَعُوا فِي الْأَرْضِ وَ نَجَعَلَهُمْ أَئِمَّةً وَ نَجَعَلَهُمُ الْوَارِثِينَ
وَ نُرِيدُ أَنْ نَمُنَّ عَلَى

“And We intend to bestow our favour upon those who were considered weak in the land and to make them the Aimma and to make them the heirs.” **Suratul Qasas - 28:5**

Imam's army will consist of 10.000 mu'mineen. He will fight Kufr and the forces of Sufyani and Dajjal and will gain victory. His objective will be the complete eradication of injustice.

“Beware, it will be tomorrow and the morrow will come soon with things which you do not know. The Man in power i.e. Imam Muhammad Al-Mahdi (pbuh) not from this crowd will take to task all those who were formerly appointed i.e. leaders for their ill deeds. The earth will pour forth its internal treasures and bring before him easily her keys. He will show you the just way of behaviour and

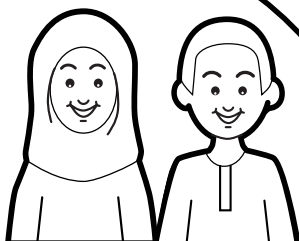

revive the Qur'an and Sunna which will have become lifeless (among people).” **Imam Ali (pbuh) - Nahjul Balagha**

The conditions prevailing in this world before his dhuhur will be a decline in the human being's moral life, when oppression and tyranny will be rampant and when mankind will have fallen into the abyss of crime and immorality. Humanity would be tired and fed up with the shape of things and would quite naturally look forward to a saviour for its liberation.

“When the situation is like this, then the Head of the Religion (Imam Muhammad Al-Mahdi A.S.) will rise and people will gather around him as pieces of rainless cloud during autumn.” **Imam Ali (pbuh)**

Having liberated humanity from its misery and curse, Imam will then bring about a transformation of life in which justice, peace, virtue and righteousness will abound. Thus will the Awaited Saviour accomplish his mission.

“He will direct desires towards guidance while people will have turned to desires and he will turn their views to the direction of the Qur'an while the people will have turned the Qur'an to their views”. **Imam Ali (pbuh)**

Imam will establish his government in Kufa and his treasury in Masjidus Sahla.

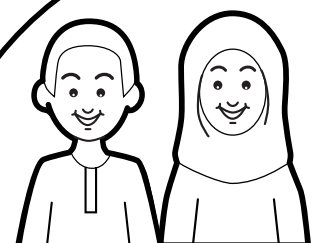

IMAM MUHAMMAD AL-MAHDI (pbuh) IS OUR GUIDE!

One day, a good man called Syed Muhammad Amili was travelling through the desert with a group of people, when he got lost.

Syed Amili searched and searched for his group but could not find them.

It soon became dark. He was tired, hungry, frightened and alone in the hot desert.

He was preparing to die when suddenly he saw some water. He went to the water, drank some and then did Wudhu and prayed his Salaaat.

After his Salaaat he felt very weak, and just lay there.

All of a sudden he saw a person riding a horse getting closer and closer to him.

When the rider reached Syed Amili, he greeted him and asked him what the matter was. Syed Amili explained that he was lost and hungry.

On hearing this, the rider asked why Syed Amili had not eaten the melons that were behind him. Syed Amili turned around, and was surprised to find some melons.

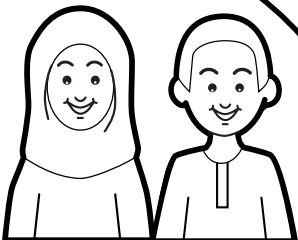

The rider then told him to eat one melon and take the rest with him and pointed out the direction he was to go in to find his group. Then the rider disappeared.

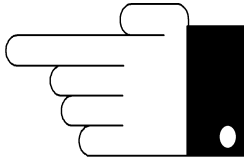

Syed Amili then realised that it was our 12th Imam, Imam Muhammad al-Mahdi (pbuh), who had helped him. Syed Amili reached his group safely.

Moral:

Although we cannot see our 12th Imam, he can see us and he knows when we need his help, and he comes to help us.

ANSWER THE FOLLOWING QUESTIONS:

1. What did Syed Amili do when he saw the water in the desert?

2. What advice did the rider give to Syed Amili?

3. Who was the rider?

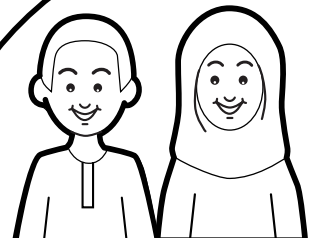

Imam

Imam means Leader

Circle all the things you would do as a follower for your Imam -
Imam Muhammad Al-Mahdi (pbuh)

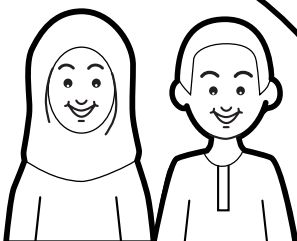
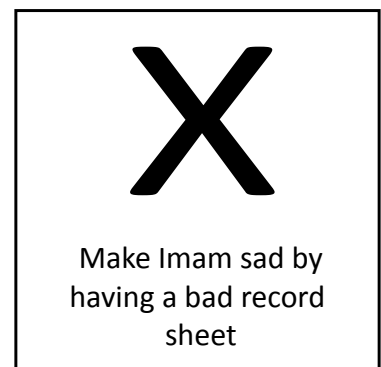
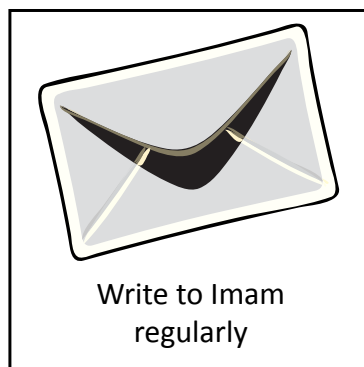
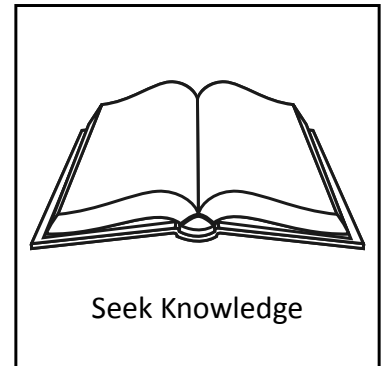
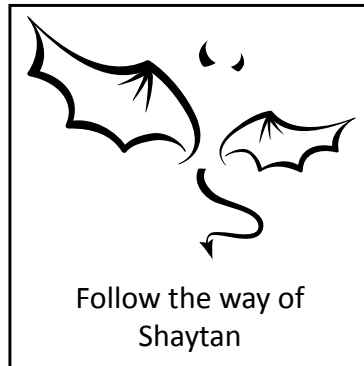
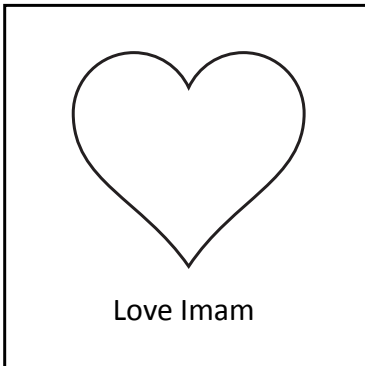
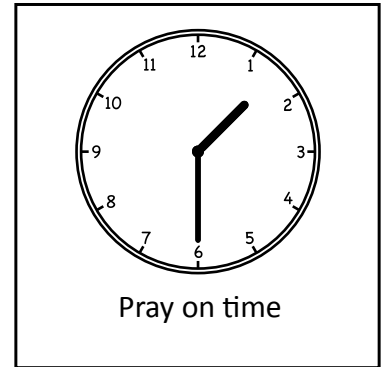
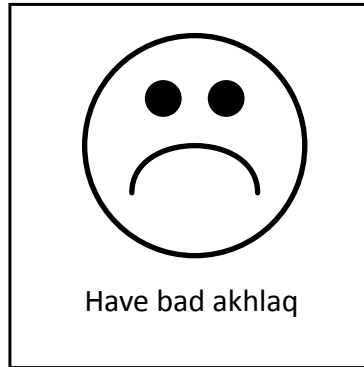
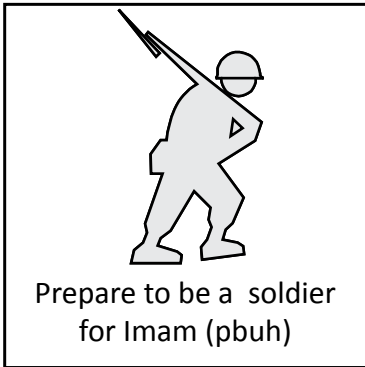

I Know my Imam...

My present Imam

Full Name:

Father's Name:

Mother's Name:

Date of Birth:

Place of Birth:

Children and Names:

.....

.....

Date of Death:

Burial Site:



One who guides
even though we
cannot see him

One Hadith / Saying:

Another Hadith / Saying:

The Ma'sum who:

.....
(write one specific aspect of his life by which you can remember him).

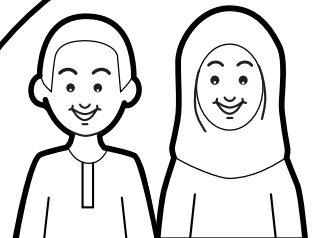

ZIYARA

السَّلَامُ عَلَيْكَ يَا رَسُولَ اللَّهِ

السَّلَامُ عَلَيْكَ يَا أَمِيرَ الْمُؤْمِنِينَ

السَّلَامُ عَلَيْكَ يَا فَاطِمَةَ الزَّهْرَاءِ

السَّلَامُ عَلَيْكَ يَا خَدِيجَةَ الْكُبْرَى

السَّلَامُ عَلَيْكَ يَا حَسَنَ الْمُجْتَبَى

السَّلَامُ عَلَيْكَ يَا أَبَا عَبْدِ اللَّهِ الْحُسَيْنِ

وَعَلَى تِسْعَةِ الْمَعْسُومِينَ مِنْ ذُرِّيَّتِكَ

عَلِيِّ بْنِ الْحُسَيْنِ وَ مُحَمَّدِ بْنِ عَلِيٍّ وَ جَعْفَرِ بْنِ مُحَمَّدٍ وَ مُوسَى بْنِ جَعْفَرٍ وَ

عَلِيِّ بْنِ مُوسَى وَ مُحَمَّدِ بْنِ عَلِيٍّ وَ عَلِيِّ بْنِ مُحَمَّدٍ وَ الْحَسَنِ بْنِ عَلِيٍّ وَ

الْحُخَّةِ بْنِ حَسَنِ عَجَلِ اللَّهُ فَرَجَهُ وَ سَهَّلَ اللَّهُ مَخْرَجَهُ وَ ظَهَّرَهُ

وَ السَّلَامُ عَلَيْكُمْ وَ رَحْمَةُ اللَّهِ وَ بَرَكَاتُهُ

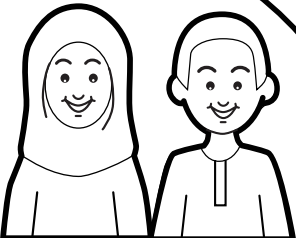



www.qfatima.com

Copyright © 2010 Q Fatima